

EN

SALTO Neoxx | [User Manual](#)

The SALTO Neoxx Padlock offers a unique solution for all those projects that needs an additional level of security to control very specific doors, without losing a piece of convenience and control.



INDEX

PRODUCT DESCRIPTION	2
WHATS IN BOX	2
ACCESORIES	2
SALTO Neoxx Padlock RANGE	3
MODELS	3
DIMENSIONS	3
CERTIFICATIONS	4
TECHNICAL DATA	4
ACCESS CONTROL FEATURES	4
OPENING MODELS	5
TIMEZONES	5
EVENT AUDITOR	5
INSTALLATION	5
PROGRAMMING	5
BATTERIES	6
SALTO Neoxx Padlock SIGNALS	7

PRODUCT DESCRIPTION

SALTO Neoxx Padlock is a battery operated electronic padlock that brings all the advantages and benefits of an access control without wiring the door reducing installation costs and allowing you to control and manage virtually any kind of door.

The SALTO Neoxx Padlock offers a unique solution for all those projects that needs an additional level of security to control very specific doors, gates or storages, without losing a piece of convenience and control.

A wire free fully stand-alone electronic access control solution, it is suitable for installation in almost every type of situations that requires a padlock locking solution.

WHATS IN THE BOX

When you purchase a SALTO Neoxx Padlock, you get:

- SALTO Neoxx electronic padlock
- 4 battery LR1 type (SALTO just warrantee the correct and best autonomy with Alkaline LR1 Energivm batteries)
- Installation guide

WARNING: for the maintenance of the cylinder in order to perform replacement of batteries, SALTO recommends to purchase the Installation tool (SP226009 - sold separately).

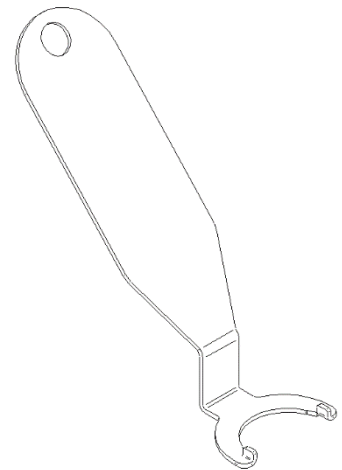

ACCESSORIES

- Battery replacement tool (SP226009).
- 4 LR1 battery for SALTO Neo cylinders (SP01926-5).

WARNING: "The product should not be modified in any way except in accordance with those modifications described in the instructions".



SP01926-5

SALTO Neox Padlock RANGE

MODELS

- P4 = Padlock. NxP4xx..

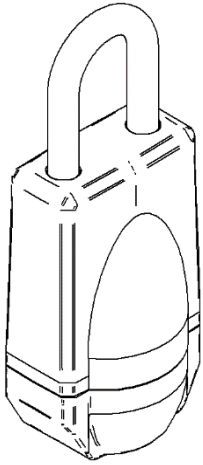

DIMENSIONS

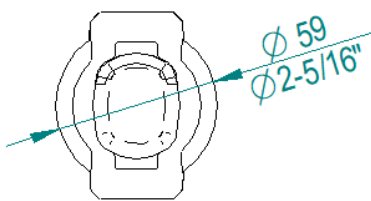

Standard

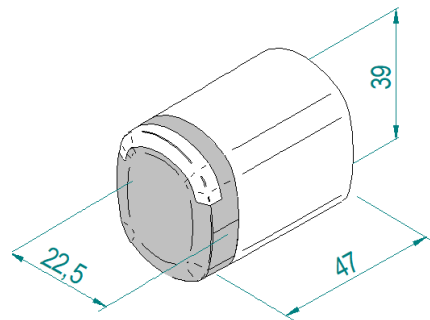
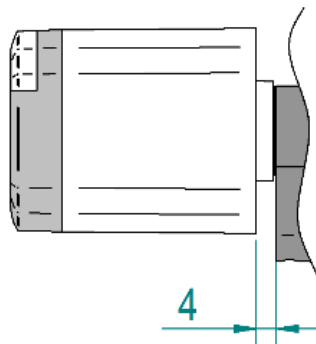

Knob

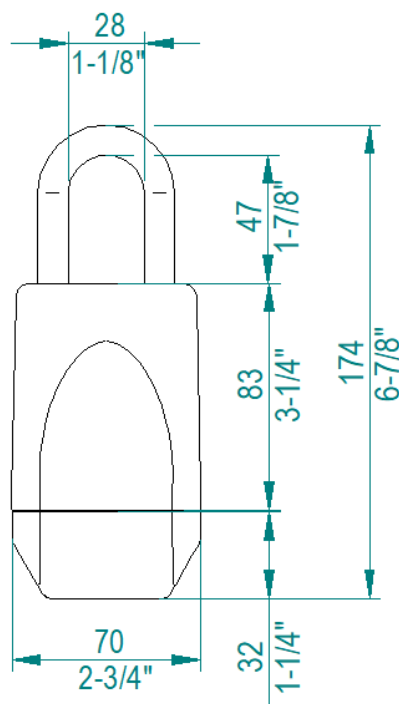
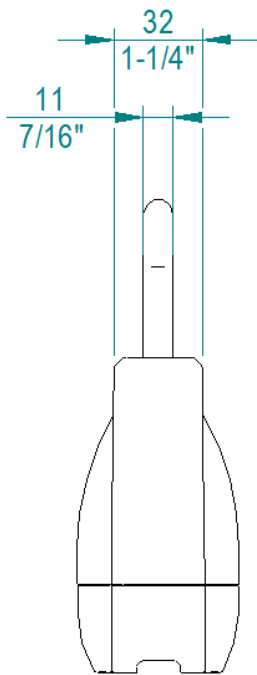

CERTIFICATIONS

- CE
 - FCC
 - IC
 - RCM
 - MIC
-
- EN 16864 (1 1 4 4 – D 3 4)
 - IEC 60529 (IP66)

TECHNICAL DATA

- **CURRENT REQUIRED** 4 x LR1 batteries.
 - **ENVIRONMENTAL CONDITIONS:** -20 °C / +55 °C (without condensation).
-35 °C* / +55 °C (exterior, only MIFARE).
- (*) Battery life reduced significantly.
- **ACCESS CONTROL SYSTEM:**
 - RW System.
 - SALTO KS System.

ACCES CONTROL FEATURES

	RW System	SALTO KS System
Maximum number of users per door	4,000,000	1000 for IQ1 10000 for IQ2
Maximum number of door per system	65,000	Unlimited
Maximum events on lock audit	2,200	1462 (BLUEnet) 472 (RFnet)
Time zones	1,024	-
Time periods	256	128
Calendars in system	256	-
User groups	Unlimited	Unlimited
Management software	ProAccess SPACE	SALTO KS

OPENING MODELS

- **STANDARD:** locked at all times.
- **OFFICE:** Free passage ability.
- **TIMED OFFICE:** free passage with automatic locking.
- **AUTOMATIC OPENING:** 8 pairs of “hands free” timed lock and unlocks per day with holidays.
- **AUTOMATIC OPENING + OFFICE.**
- **TOGGLE:** present card to lock, present card to unlock.
- **TIME TOGGLE:** present card to lock, present card to unlock depending on schedules.
- **TWO PERSON RULE:** present two valid cards to unlock.

TIMEZONES

Each user can be assigned to a calendar and a time table consists of up to 8 different time intervals with a resolution of 10 minutes assigned to each day of the week. You can also distinguish between holidays, special days and working days.

EVENT AUDITOR

- Authorized access events auditor registration, denied access events auditor registration, system maintenance events auditor registration (low battery, PPD connection,...) and automatic actions events auditor registration (automatic opening...).
- Each event is logged: event type, user, date and time of the event.
- Permanent events registration. Non-volatile memory of the last X events (see table).
- The events are saved in a non-volatile memory, so the events are recorded forever.
- The events are saved in a “Ring buffer” system. When the event storage capacity is full, creating a new event removes the last one.

INSTALLATION



To install the SALTO Neox Padlock: following the instructions attached with the product, or visiting our website:

www.saltosystems.com/en/quick-links/manuals-and-guides/

PROGRAMMING

To grant or deny access permissions are used to the right SW license. Once you update the system configuration:

- **RW SYSTEM:** the system allows electronic cylinders to read, receive and write information via its operating smart cards or “intelligent keys”. This data is captured from the cards at SVN on-line hot spots located at strategic points around the building. The “online points” uploads and downloads user related information that is then used to permit, control or deny access.
- **KS SYSTEM:** the system allows electronic cylinders to read, receive and write information via radio SALTO KS.

BATTERIES

In the case of complete battery failure the product both safe and secure, i.e. the outside handle fails “locked” to avoid intrusions, the inside handle fails “open” to permit emergency openings.

If the batteries are removed, the product does not work. If they are put back again, the product works but it loses the RTC. If it is an online access point, the RTC is recovered instantly. If not, the access point must be programmed again. When the product has lost the RTC, if the user does not have time restrictions, it opens. However, if the user has time restrictions, the access point does not open even if the user has access to it.

There are 3 different possibilities regarding the power level of the batteries:

- **Low level batteries:** “Low battery status” signalization, the event is recorded and the access point opens when a valid card is presented.
- **Very low batteries:** “Low battery status” signalization, the event is recorded but the access point does not open even if a valid card is presented.
- **Extremely low level batteries:** the access point does not work.



WARNING: *electronic cylinder in standalone or offline mode needs to be update with the PPD to recover the hour. “The product should not be modified in any way except in accordance with those modifications described in the instructions”.*

SALTO just warrantee the correct and best autonomy with Alkaline LR1 Energivm – batteries (SP01926-5).

SALTO Neo SIGNALS

ACCESS GRANTED

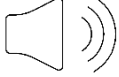

Present a valid user key and get the access granted.

	
1 High pitched beep	1 Green light



ACCESS DENIED

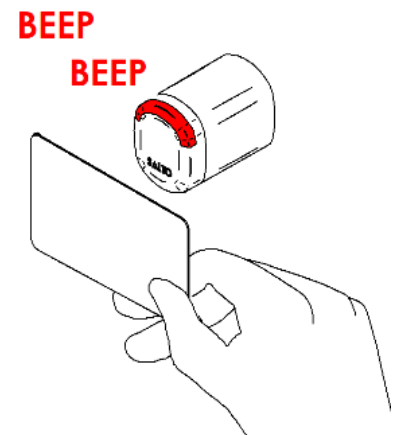

Present a not valid user key and get the access denied.

	
2 Short low pitched beeps	2 Red lights



LOW BATTERY STATUS

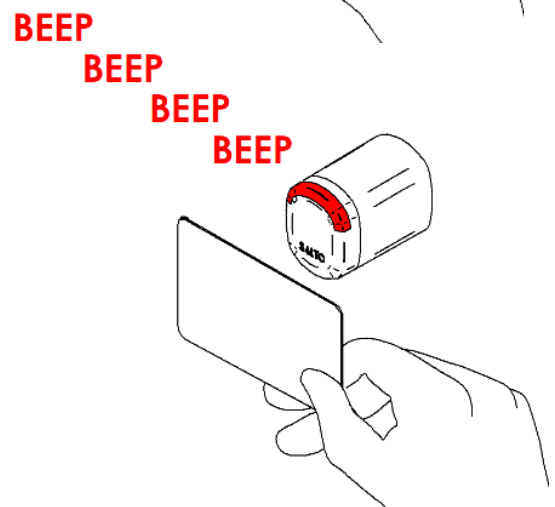

After presenting a valid user card that has access to the door and opening the door, the cylinder will show 4 light red signal and then grant the access.

	
4 Short low pitched beeps	4 Red lights



BATTERY CHANGE (RESET)

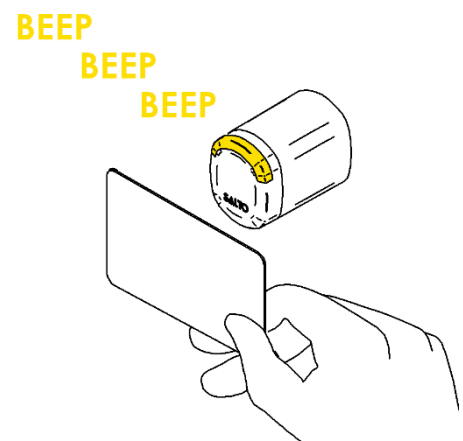

Each time you change the batteries, the electronic will do a reset. The cylinder memory will not be erased. To show this reset, the cylinder show yellow lights with a lite sound.

	
3 Short low pitched beeps	3 Yellow lights



OFFICE MODE NOTICE

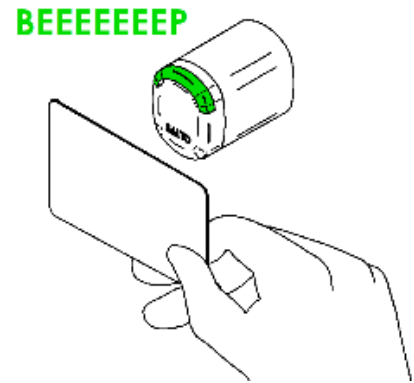

Present a valid user key, the cylinder show a green light with a lite sound. The cylinder is in “office mode”.

	
1 High pitched beep	1 Green light



ACCESS GRANTED IN OFFICE MODE

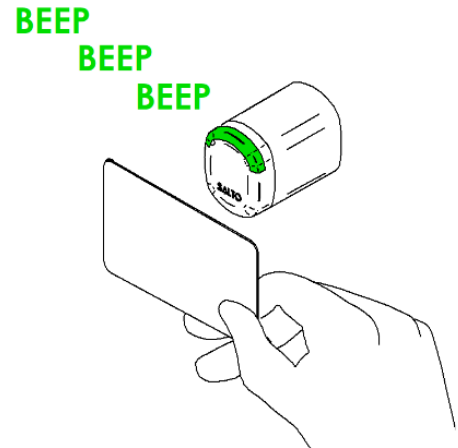

Present a valid user key, the cylinder show 3 green lights with a lite sound and get the access granted.

	
3 Short high pitched beeps	3 Green lights



ACCESS DENIED IN OFFICE MODE

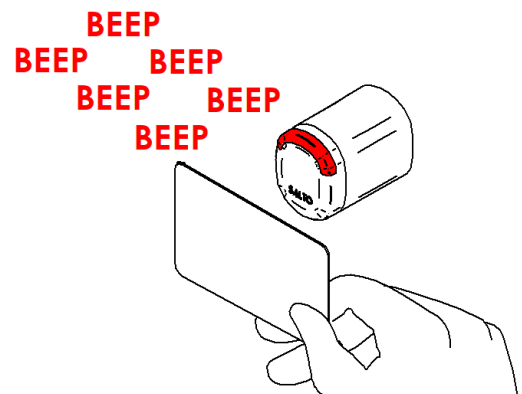

Present a not valid user key, the cylinder show red lights with a lite sound and get the access denied.

	
6 Short high pitched beeps	6 Red lights



OFFICE MODE END

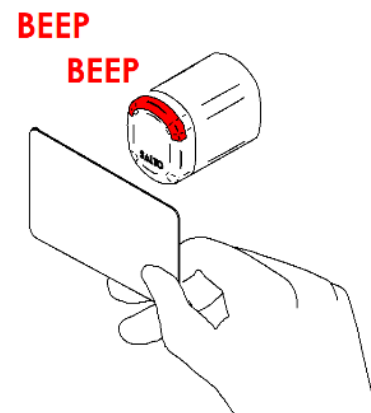

Present a valid user key, the cylinder show 2 red lights with a lite sound. The “office mode” is over.

	
2 Short low pitched beeps	2 Red lights



ACCESS GRANTED + TOOGLE

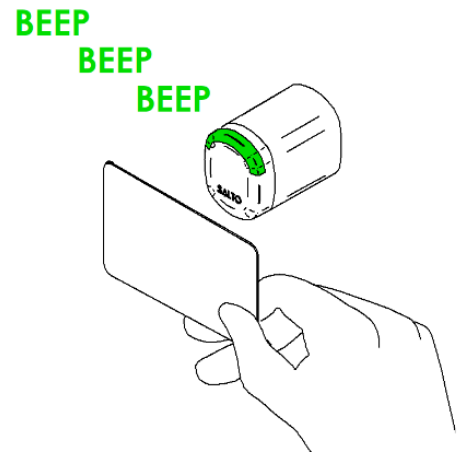

After presenting a valid user card with “TOOGLE” credentials, the SALTO Neo cylinder will start the “TOOGLE” mode. This will be shown by 3 green lights and high pitched beeps.

	
3 Short low pitched beeps	3 Green lights



END TOOGLE

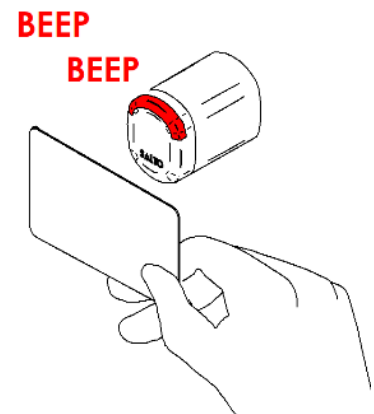

After presenting a valid user card with “TOOGLE” credentials, the SALTO Neo cylinder will end the “TOOGLE” mode. This will be shown by 2 red lights and low pitched beeps.

	
2 Short low pitched beeps	2 Red lights



SECURITY ERROR

When the cylinder shows continuous blinking light Finished and a combination of high and low pitched beeps and yellow lights, it means that the knob and the cylinder are not paired and they can not be mounted together.

	
Short / low pitched beeps	Yellow lights

