

ART.

• 5CM.550.SP10.10

- Piedino (100mm) registrabile (± 20) con pinza per pannello di spessore 10mm
- 100 mm Adjustable foot (± 20 mm) with clamp for 10mm laminate panels
- Pied (100mm) réglable (± 20 mm) avec pince pour panneau épaisseur 10mm
- Regulierbarer Fuss (80mm-120mm) für Laminatpaneel 10mm
- Pie regulable (80mm-120mm) para paneles de laminado 10mm de espesor
- Regelbare voet (80mm-120mm) voor paneel 10mm

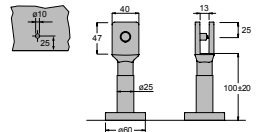
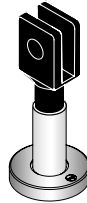

ART.

• 5CM.550.SP13.10

- Piedino (100mm) registrabile (± 20) con pinza per pannello di spessore 13mm
- 100 mm Adjustable foot (± 20 mm) with clamp for 13mm laminate panels
- Pied (100mm) réglable (± 20 mm) avec pince pour panneau épaisseur 13mm
- Regulierbarer Fuss (80mm-120mm) für Laminatpaneel 13mm
- Pie regulable (80mm-120mm) para paneles de laminado 13mm de espesor
- Regelbare voet (80mm-120mm) voor paneel 13mm

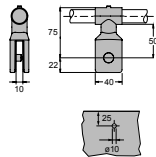

ART.

5CM.551.SP10.10

- Pinza superiore per pannello di spessore 10mm, con innesto tubo in linea o perpendicolare
- Top panel holder for panels 10mm thickness, inline or 90° degrees
- Pince supérieure pour panneau épaisseur 10mm, avec raccord tube en ligne ou perpendiculaire
- Oberer Halter zur Befestigung Panele 10mm, Rohreinsatz 90° versetzt oder in Linie
- Pinza superior para fijación de panel 10mm con racor para tubo perpendicular o in linea
- Boven paneel 10mm bevestigingsklem met loodrechte buisverbinding of in lijn

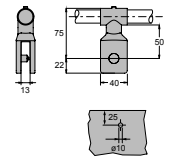

ART.

5CM.551.SP13.10

- Pinza superiore per pannello di spessore 13mm, con innesto tubo in linea o perpendicolare
- Top panel holder for panels 13mm thickness, inline or 90° degrees
- Pince supérieure pour panneau épaisseur 13mm, avec raccord tube en ligne ou perpendiculaire
- Oberer Halter zur Befestigung Panele 13mm, Rohreinsatz 90° versetzt oder in Linie
- Pinza superior para fijación de panel 13mm con racor para tubo perpendicular o in linea
- Boven paneel 13mm bevestigingsklem met loodrechte buisverbinding of in lijn

XX = FINITURA
FINISH
FINITION
AFWERKING
AUSFÜHRUNG

* DOTAZIONE PER FISSAGGI INCLUSA
FIXING KIT INCLUDED
EQUIPEMENT POUR LES FIXATIONS FOURNIES
BEVESTIGINGS INBEGRIP
BEVESTIGINGSSET INCLUSIEF

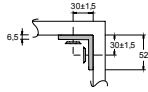

ART.

* 5CM.552.0000.10

- Angolare per fissaggio
- Angle bracket to fix panels
- Equerre pour fixation
- Winkel zur Befestigung Panele
- Escuadra para fijación de paneles
- Paneel bevestigingshoek

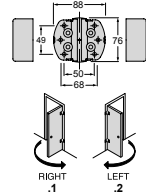
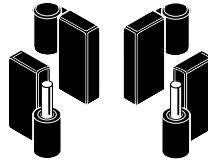

ART.

* 5CM.553.0000.10.2 Sinistra / Left / Gauche / Links / Izquierda / Links
 * 5CM.553.0000.10.1 Destra / Right / Droite / Rechts / Derecha / Rechts

- Cerniera coplanare
- Coplanar hinge for hand panels
- Charnière applique
- Gleitscharnier für Panele
- Bisagra para paneles
- Scharnier voor paneel

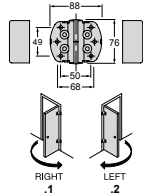
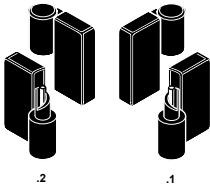

ART.

* 5CM.554.000A.10.2 Sinistra / Left / Gauche / Links / Izquierda / Links
 * 5CM.554.000A.10.1 Destra / Right / Droite / Rechts / Derecha / Rechts

- Cerniera coplanare autoaprente
- Self-opening coplanar hinge for hand panels
- Charnière applique à ouverture automatique
- Gleitscharnier für Panele selbstöffnend
- Bisagra para paneles de auto-apertura
- Scharnier voor paneel voor automatisch openende deur

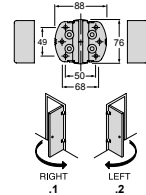
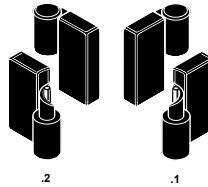

ART.

* 5CM.554.000C.10.2 Sinistra / Left / Gauche / Links / Izquierda / Links
 * 5CM.554.000C.10.1 Destra / Right / Droite / Rechts / Derecha / Rechts

- Cerniera coplanare autochudente
- Self-closing coplanar hinge for hand panels
- Charnière applique à fermeture automatique
- Gleitscharnier für Panele selbstöffnend
- Bisagra para paneles de auto-cierre
- Scharnier voor paneel voor automatisch sluitende deur

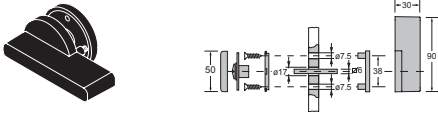

ART.

5CN.558.00LE.10

- Chiusino libero/occupato con leva
- Snib with vacant/engaged indicator and locking lever
- Dispositif de fermeture libre/occupé avec levier
- Frei-Besetzt Garnitur mit Verriegelung
- Muletilla libre/ocupado con manilla de cierre para puerta
- Vrij/bezet eenheid met grendel

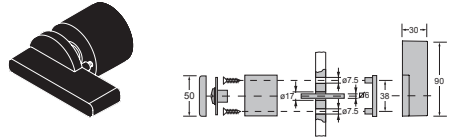

ART.

5CN.559.00LE.10

- Chiusino libero/occupato con leva e pomolo
- Snib with vacant/engaged indicator, locking lever and door knob
- Dispositif de fermeture libre/occupé avec levier et bouton
- Frei-Besetzt Garnitur mit Verriegelung und Türkнопf
- Muletilla libre/ocupado con manilla de cierre para puerta y pomolo
- Vrij/bezet eenheid met grendel en knop



ART.

5CS.558.0LEE.44

- Chiusino libero/occupato con leva in alluminio
- Snib with vacant/engaged indicator with aluminium lever
- Dispositif de fermeture libre/occupé avec levier en aluminium
- Frei-Besetzt Garnitur mit Griff in Aluminium
- Muletilla libre/ocupado con manilla de cierre para puerta de aluminio
- Vrij/bezet eenheid met grendel voor aluminium deur

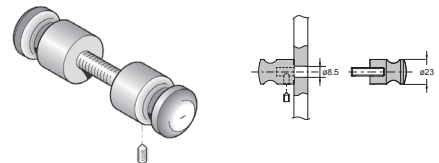

ART.

5CS.564.000D.44

- Pomolo doppio e fisso
- Double fixed knob
- Bouton double et fixe
- Doppelter Türkнопf für Panele
- Doble pomolo para panel
- Dubbele knop voor paneel

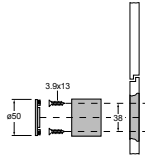
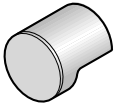

ART.

5CN.564.0000.10

- Pomolo fisso
- Fixed knob
- Bouton fixe
- Türkknopf feststehend
- Pomo fijo
- Vaste knop

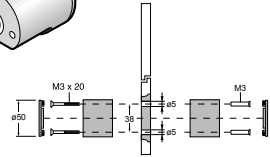
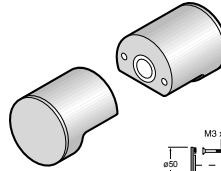

ART.

5CN.564.000D.10

- Appendiabiti
- Cloth hook
- Portemanteau
- Kleiderhaken einfach
- Colgador para panel
- Kapstok

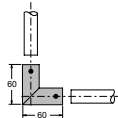
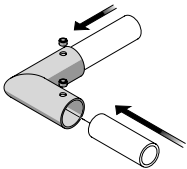

ART.

5CM.556.0000.44

- Giunto a 90° a 2 vie, per unione art.5CS.560.0000
- 90° degree top joint, two way, to suit art.5CS.560.0000
- Raccord 90° 2 voies pour jonction art.5CS.560.0000
- Verbindungselement 22mm - Rohr 22mm 2 seitig 90°
- Codo 90° - tubo 22mm
- Verbindung 22mm - buis 22mm 2 richtingen 90°

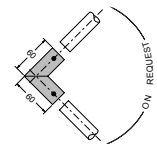
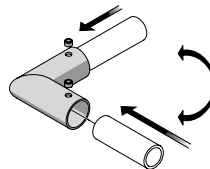

ART.

5CM.557.9999.44

- Giunto, con angolo a richiesta, a 2 vie, per unione art.5CS.560.0000
- Universal top joint, two way, to suit art.5CS.560.0000, please state angle required
- Raccord, avec angle sur demande, 2 voies pour jonction art.5CS.560.0000
- Verbindungselement 22mm - Rohr 22mm 2 seitig, Winkel auf Anfrage
- Codo especial angulo a medida - tubo 22mm
- Verbindung 22mm - buis 22mm 2 richtingen - hoek volgens opgave

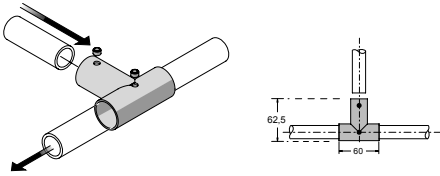

ART.

5CM.561.0000.44

- Giunto a 3 vie per unione art.5CS.560.0000
- Top T-joint, three way, to suit art.5CS.560.0000
- Raccord 3 voies pour jonction art.5CS.560.0000
- Verbindungselement 22mm - Rohr 22mm 3 seitig
- Unión en T - tubo 22mm
- Verbindingsstuk 3 wegs voor buis 22mm

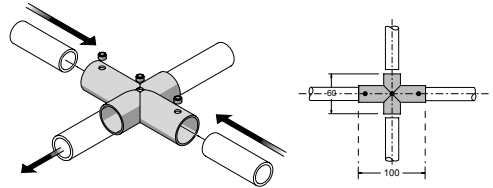

ART.

5CM.561.000B.44

- Giunto a 4 vie per unione art.5CS.560.0000
- Top X-joint, four way, to suit art.5CS.560.0000
- Raccord 4 voies pour jonction art.5CS.560.0000
- Verbindungselement 22mm - Rohr 22mm 4 seitig
- Unión en X cruce para tubo 22mm
- Verbindingsstuk 4 wegs voor buis 22mm

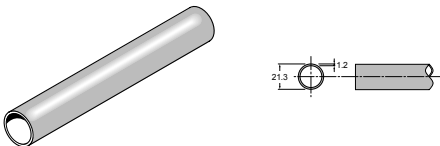

ART.

5CS.560.0000.44

- Tubo superiore in barre da 3 metri
- Top rail tube, 3 metres long
- Tube supérieur en barre de 3 mètres
- Oberes Stützrohr 21,3 mm, 3 Meter
- Tubo superior de soporte, diámetro 21,3 mm, 3 metros
- Steunbuis boven 21,3 mm, lengte 3 meter

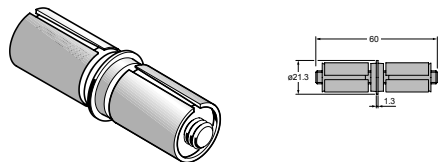

ART.

5CS.563.0000.00

- Giunzione per unione art.5CS.560.0000 con art.5CS.560.0000
- Tube connector, expanding plug to suit art.5CS.560.0000 connection
- Raccord pour jonction art.5CS.560.0000 avec art.5CS.560.0000
- Expansions - Verbindungselement Rohr 22mm - Rohr 22mm
- Unión para tubo 22mm - tubo 22mm de expansión
- Rechte verbinding voor buis 22mm uitbreiding

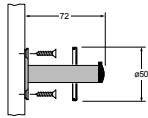
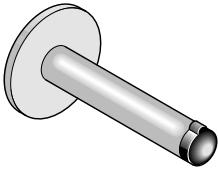

ART.

5CS.562.0000.44

- Appendiabiti/fermaporta
- Door-stop and clothes hook
- Butoir portemanteau
- Türstopper Kleiderhaken
- Tope de puerta colgador
- Deurstop-kledinghanger

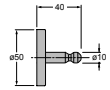
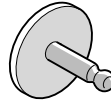

ART.

4CS.488.0000.44

- Appendiabiti
- Cloth hook
- Portemanteau
- Kleiderhaken einfach
- Colgador sencillo
- Kleerhanger enkel

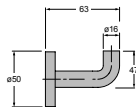
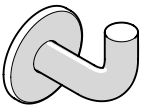

ART.

4CS.488.000C.44

- Appendiabiti
- Cloth hook
- Portemanteau
- Kleiderhaken einfach
- Colgador sencillo
- Kleerhanger enkel

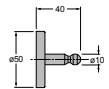
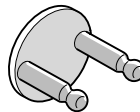

ART.

4CS.488.000D.44

- Appendiabiti
- Cloth hook
- Portemanteau
- Kleiderhaken einfach
- Colgador sencillo
- Kleerhanger enkel

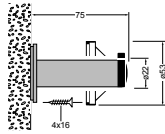
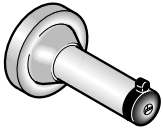

ART.

5CN.562.0000.10

- Appendiabiti/fermaporta
- Door-stop and clothes hook
- Butoir portemanteau
- Türstopper
- Tope para puerta
- Deurstop

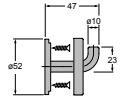

ART.

4CN.488.000P.10

- Appendiabiti
- Cloth hook
- Portemanteau
- Kleiner Kleiderhaken für Panele
- Colgador pequeño para panel
- Kleerhanger dubbel voor paneel

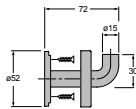

ART.

4CN.488.0000.10

- Appendiabiti
- Cloth hook
- Portemanteau
- Kleiner Kleiderhaken für Panele
- Colgador pequeño para panel
- Kleerhanger dubbel voor paneel

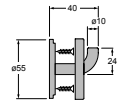
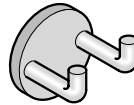

ART.

4CN.488.000D.10

- Appendiabiti
- Cloth hook
- Portemanteau
- Kleiner Kleiderhaken für Panele
- Colgador pequeño para panel
- Kleerhanger dubbel voor paneel

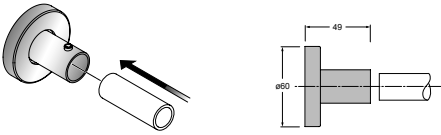

ART.

* 5CM.555.0000.44

- Rosetta registrabile per fissaggio art.5CS.560.0000 a parete
- Adjustable wall fixing rose for art.5CS.560.0000
- Rosace réglable pour fixation art.5CS.560.0000 à paroi
- Befestigungsrosette Rohr 21,3 mm auf Wand regulierbar
- Roseta de fijación de tubo 21,3 mm en pared de giro libre
- Rozet voor muurbevestiging buis 21,3 mm regelbaar

IT				* colori indicativi				GB				* indicative colors				FR				* couleurs indicatives									
CODICE - CODE	MATERIALE	FINITURA	.XX *	MATERIAL	FINISH	.XX *	MATERIEL	FINITION	.XX *	MATERIAL	FINISH	.XX *	MATERIEL	FINITION	.XX *	MATERIAL	FINISH	.XX *	MATERIEL	FINITION	.XX *								
01T. KLO.V 2CC. KLO. 2CE. KLS. 2CP. KLH. 2CF. KLP. 2DM. KLR. EDS. 5CG. HGL. 5CS. HGU. 400-SS 400-HR-SS	ACCIAIO INOX AISI 316L	Di produzione: SATINATO	.44	STAINLESS STEEL AISI 316L	Standard: SATIN	.44	ACIER INOXIDABLE AISI 316L	Standard: SATINE A la demande: POLI	.44	ACCIAIO INOX AISI 316L + LEGNO	Di produzione: Wenge + LEGNO Frassinio Mogano	.46 .47 .48	ACIER INOXIDABLE AISI 316L + BOIS	Standard: SATINE + BOIS	Wenge Frene Acajou	.46 .47 .48	ACCIAIO INOX AISI 316L + PELLE	Di produzione: Nero + PELLE Beige Marrone Rosso	.4A .4B .4C .4D	ACIER INOXIDABLE AISI 316L + CUIR	Standard: Noir + CUIR Beige Marron Rouge	.4A .4B .4C .4D							
		A richiesta: LUCIDO	.43		Upon Request: BRIGHT	.43		A la demande: POLI	.43		A richiesta: LUCIDO + LEGNO Frassinio Mogano	.49 .50 .51		Upon Request: BRIGHT + WOOD	Ash Mahogany	.49 .50 .51		A la demande: POLI + BOIS	Wenge Frene Acajou		.49 .50 .51	A richiesta: LUCIDO + PELLE Nero Beige Marrone Rosso	.3A .3B .3C .3D	Upon Request: BRIGHT + LEATHER	Black Biscuit Brown Red	.3A .3B .3C .3D			
		A richiesta: PVD su articoli selezionati (*)	.89 .90 .91		Upon Request: Copper Bronze Satin PVD on selected items (*)	.89 .90 .91		A la demande: Copper Bronze Satin PVD sur produits sélectionnés (*)	.89 .90 .91		A richiesta: LUCIDO + PELLE Nero Beige Marrone Rosso	.3A .3B .3C .3D		Upon Request: BRIGHT + LEATHER	Black Biscuit Brown Red	.3A .3B .3C .3D													
		Black Satin	.93		Black Satin	.93		Black Satin	.93		Black Satin	.93		Black Satin	.93	Black Satin		.93	Black Satin		.93	Black Satin	.93	Black Satin	.93	Black Satin	.93	Black Satin	.93
		Black Bright	.94		Black Bright	.94		Black Bright	.94		Black Bright	.94		Black Bright	.94	Black Bright		.94	Black Bright		.94	Black Bright	.94	Black Bright	.94	Black Bright	.94	Black Bright	.94
Chocolate Satin	.95	Chocolate Satin	.95	Chocolate Satin	.95	Chocolate Satin	.95	Chocolate Satin	.95	Chocolate Satin	.95	Chocolate Satin	.95	Chocolate Satin	.95	Chocolate Satin	.95	Chocolate Satin	.95	Chocolate Satin	.95	Chocolate Satin	.95						
YOD KLL	ACCIAIO INOX AISI 316L + PELLE	Di produzione: SATINATO	.4A	ALUMINIUM	Standard: ANODIZED	Champagne	.66	ALUMINIUM	Standard: ANODISE	Champagne	.66	NYLON	Standard: BLANC	.01	ALUMINIUM	Standard: LAQUE	Noir	.26	ACIER INOX AISI 316L	POLI PVD	Or	.81							
		A richiesta: LUCIDO	.68		Upon Request: POWDER COATED	Black	.68		A la demande: LAQUE	Black	.68		A la demande: LAQUE	Black		.68	A la demande: LAQUE	Black		.68	A la demande: LAQUE	Black	.68	A la demande: LAQUE	Black	.68			
3CC	NYLON	Di produzione: BIANCO	.01	NYLON	Standard: WHITE	.01	NYLON	Standard: BLANC	.01	M18	Di produzione: NERO	.26	ALUMINIUM	Standard: LAQUE	Noir	.26	ACIER INOX AISI 316L	POLI PVD	Or	.81									
		A richiesta: GIALLO	.04		Upon Request: YELLOW	.04		A la demande: JAUNE	.04		A la demande: JAUNE	.04		A la demande: JAUNE	.04	A la demande: JAUNE		.04	A la demande: JAUNE	.04	A la demande: JAUNE	.04	A la demande: JAUNE	.04	A la demande: JAUNE	.04			
5CA 5CN	ALLUMINIO NYLON	ANODIZZATO	Argento	.62	ALUMINIUM NYLON	ANODIZED	Silver	.62	ALUMINIUM NYLON	ANODISE	Argent	.62	ALUMINIUM NYLON	ANODISE	Argent	.62	ACIER INOX AISI 316L + NYLON	POLI PVD	Or	.81									
		Di produzione: BIANCO	.01	Standard: WHITE		.01	A la demande: BLANC	.01		A la demande: BLANC	.01	A la demande: BLANC		.01	A la demande: BLANC	.01		A la demande: BLANC	.01	A la demande: BLANC	.01	A la demande: BLANC	.01	A la demande: BLANC	.01				
400-NY 400-HR-NY	ACCIAIO INOX AISI 316L + NYLON	Di produzione: SATINATO	.44	STAINLESS STEEL AISI 316L + NYLON	Standard: SATIN	.44	NYLON	Standard: WHITE PLUS	.A1	NYLON	Di produzione: NERO	.10	ALUMINIUM LAQUE	Standard: BLANC	.30	ALUMINIUM LAQUE	Standard: GRIS	.24	ACIER INOX AISI 316L + NYLON	POLI PVD	Or	.81							
		A richiesta: LUCIDO	.10		Standard: BLACK	.10		A la demande: NOIR	.10		A la demande: NOIR	.10		A la demande: NOIR	.10		A la demande: NOIR	.10		A la demande: NOIR	.10	A la demande: NOIR	.10	A la demande: NOIR	.10	A la demande: NOIR	.10		
400-NY 400-HR-NY	NYLON	BIANCO PLUS	.A1	NYLON	WHITE PLUS	.A1	NYLON	WHITE PLUS	.A1	NYLON	BIANCO PLUS	.A1	ALUMINIUM LAQUE	BLANC PLUS	.A1	ALUMINIUM LAQUE	GRIS	.24	ACIER INOX AISI 316L + NYLON	POLI PVD	Or	.81							
		BIANCO	.01		WHITE	.01		BIANCO	.01		BLANC	.01		BIANCO	.01		BLANC	.01		BLANC	.01	BLANC	.01	BLANC	.01	BLANC	.01	BLANC	.01
400-NY 400-HR-NY	NYLON	BISCOTTO	.02	NYLON	BISCOTT	.02	NYLON	BISCOTTO	.02	NYLON	BISCOTTO	.02	ALUMINIUM LAQUE	BISCUIT	.02	ALUMINIUM LAQUE	GRIS	.24	ACIER INOX AISI 316L + NYLON	POLI PVD	Or	.81							
		GIALLO PASTELLO	.03		LIGHT YELLOW	.03		GIALLO PASTELLO	.03		JAUNE PASTEL	.03		GIALLO PASTELLO	.03		JAUNE PASTEL	.03		GIALLO PASTELLO	.03	JAUNE PASTEL	.03	GIALLO PASTELLO	.03	JAUNE PASTEL	.03	GIALLO PASTELLO	.03
400-NY 400-HR-NY	NYLON	GIALLO	.04	NYLON	YELLOW	.04	NYLON	GIALLO	.04	NYLON	GIALLO	.04	ALUMINIUM LAQUE	JAUNE	.04	ALUMINIUM LAQUE	GRIS	.24	ACIER INOX AISI 316L + NYLON	POLI PVD	Or	.81							
		BLU PASTELLO	.05		LIGHT BLUE	.05		BLU PASTELLO	.05		BLEU PASTEL	.05		BLU PASTELLO	.05		BLEU PASTEL	.05		BLU PASTELLO	.05	BLEU PASTEL	.05	BLU PASTELLO	.05	BLEU PASTEL	.05	BLU PASTELLO	.05
400-NY 400-HR-NY	NYLON	BLU	.06	NYLON	BLUE	.06	NYLON	BLU	.06	NYLON	BLU	.06	ALUMINIUM LAQUE	BLEU	.06	ALUMINIUM LAQUE	GRIS	.24	ACIER INOX AISI 316L + NYLON	POLI PVD	Or	.81							
		GRIGIO	.07		GREY	.07		GRIGIO	.07		GRIS	.07		GRIGIO	.07		GRIS	.07		GRIGIO	.07	GRIS	.07	GRIGIO	.07	GRIS	.07	GRIGIO	.07
400-NY 400-HR-NY	NYLON	VERDE	.08	NYLON	GREEN	.08	NYLON	VERDE	.08	NYLON	VERDE	.08	ALUMINIUM LAQUE	VERT	.08	ALUMINIUM LAQUE	GRIS	.24	ACIER INOX AISI 316L + NYLON	POLI PVD	Or	.81							
		ROSSO	.09		RED	.09		ROSSO	.09		ROUGE	.09		ROSSO	.09		ROUGE	.09		ROSSO	.09	ROUGE	.09	ROSSO	.09	ROUGE	.09	ROSSO	.09
400-NY 400-HR-NY	NYLON	NERO	.10	NYLON	BLACK	.10	NYLON	NERO	.10	NYLON	NERO	.10	ALUMINIUM LAQUE	NOIR	.10	ALUMINIUM LAQUE	GRIS	.24	ACIER INOX AISI 316L + NYLON	POLI PVD	Or	.81							
		BIANCO	.01		WHITE	.01		BIANCO	.01		BLANC	.01		BIANCO	.01		BLANC	.01		BIANCO	.01	BLANC	.01	BIANCO	.01	BLANC	.01	BIANCO	.01
400-NY 400-HR-NY	NYLON	BIANCO PLUS	.A1	NYLON	WHITE PLUS	.A1	NYLON	BIANCO PLUS	.A1	NYLON	BIANCO PLUS	.A1	ALUMINIUM LAQUE	BLANC PLUS	.A1	ALUMINIUM LAQUE	GRIS	.24	ACIER INOX AISI 316L + NYLON	POLI PVD	Or	.81							
		BIANCO	.01		WHITE	.01		BIANCO	.01		BLANC	.01		BIANCO	.01		BLANC	.01		BIANCO	.01	BLANC	.01	BIANCO	.01	BLANC	.01	BIANCO	.01
400-NY 400-HR-NY	NYLON	BISCOTTO	.02	NYLON	BISCOTT	.02	NYLON	BISCOTTO	.02	NYLON	BISCOTTO	.02	ALUMINIUM LAQUE	BISCUIT	.02	ALUMINIUM LAQUE	GRIS	.24	ACIER INOX AISI 316L + NYLON	POLI PVD	Or	.81							
		GIALLO PASTELLO	.03		LIGHT YELLOW	.03		GIALLO PASTELLO	.03		JAUNE PASTEL	.03		GIALLO PASTELLO	.03		JAUNE PASTEL	.03		GIALLO PASTELLO	.03	JAUNE PASTEL	.03	GIALLO PASTELLO	.03	JAUNE PASTEL	.03	GIALLO PASTELLO	.03
400-NY 400-HR-NY	NYLON	GIALLO	.04	NYLON	YELLOW	.04	NYLON	GIALLO	.04	NYLON	GIALLO	.04	ALUMINIUM LAQUE	JAUNE	.04	ALUMINIUM LAQUE	GRIS	.24	ACIER INOX AISI 316L + NYLON	POLI PVD	Or	.81							
		BLU PASTELLO	.05		LIGHT BLUE	.05		BLU PASTELLO	.05		BLEU PASTEL	.05		BLU PASTELLO	.05		BLEU PASTEL	.05		BLU PASTELLO	.05	BLEU PASTEL	.05	BLU PASTELLO	.05	BLEU PASTEL	.05	BLU PASTELLO	.05
400-NY 400-HR-NY	NYLON	BLU	.06	NYLON	BLUE	.06	NYLON	BLU	.06	NYLON	BLU	.06	ALUMINIUM LAQUE	BLEU	.06	ALUMINIUM LAQUE	GRIS	.24	ACIER INOX AISI 316L + NYLON	POLI PVD	Or	.81							
		GRIGIO	.07		GREY	.07		GRIGIO	.07		GRIS	.07		GRIGIO	.07		GRIS	.07		GRIGIO	.07	GRIS	.07	GRIGIO	.07	GRIS	.07	GRIGIO	.07
400-NY 400-HR-NY	NYLON	VERDE	.08	NYLON	GREEN	.08	NYLON	VERDE	.08	NYLON	VERDE	.08	ALUMINIUM LAQUE	VERT	.08	ALUMINIUM LAQUE	GRIS	.24	ACIER INOX AISI 316L + NYLON	POLI PVD	Or	.81							
		ROSSO	.09		RED	.09		ROSSO	.09		ROUGE	.09		ROSSO	.09		ROUGE	.09		ROSSO	.09	ROUGE	.09	ROSSO	.09	ROUGE	.09	ROSSO	.09
400-NY 400-HR-NY	NYLON	NERO	.10	NYLON	BLACK	.10	NYLON	NERO	.10	NYLON	NERO	.10	ALUMINIUM LAQUE	NOIR	.10	ALUMINIUM LAQUE	GRIS	.24	ACIER INOX AISI 316L + NYLON	POLI PVD	Or	.81							
		BIANCO	.01		WHITE	.01		BIANCO	.01		BLANC	.01		BIANCO	.01		BLANC	.01		BIANCO	.01	BLANC	.01	BIANCO	.01	BLANC	.01	BIANCO	.01
400-NY 400-HR-NY	NYLON	BIANCO PLUS	.A1	NYLON	WHITE PLUS	.A1	NYLON	BIANCO PLUS	.A1	NYLON	BIANCO PLUS	.A1	ALUMINIUM LAQUE	BLANC PLUS	.A1	ALUMINIUM LAQUE	GRIS	.24	ACIER INOX AISI 316L + NYLON	POLI PVD	Or	.81							
		BIANCO	.01		WHITE	.01		BIANCO	.01		BLANC	.01		BIANCO	.01		BLANC	.01		BIANCO	.01	BLANC	.01	BIANCO	.01	BLANC	.01	BIANCO	.01
400-NY 400-HR-NY	NYLON	BISCOTTO	.02	NYLON	BISCOTT	.02	NYLON	BISCOTTO	.02	NYLON	BISCOTTO	.02	ALUMINIUM LAQUE	BISCUIT	.02	ALUMINIUM LAQUE	GRIS	.24	ACIER INOX AISI 316L + NYLON	POLI PVD	Or	.81							
		GIALLO PASTELLO	.03		LIGHT YELLOW	.03		GIALLO PASTELLO	.03		JAUNE PASTEL	.03		GIALLO PASTELLO	.03		JAUNE PASTEL	.03		GIALLO PASTELLO	.03	JAUNE PASTEL	.03	GIALLO PASTELLO	.03	JAUNE PASTEL	.03	GIALLO PASTELLO	.03
400-NY 400-HR-NY	NYLON	GIALLO	.04	NYLON	YELLOW	.04	NYLON	GIALLO	.04	NYLON	GIALLO	.04	ALUMINIUM LAQUE	JAUNE	.04	ALUMINIUM LAQUE	GRIS	.24	ACIER INOX AISI 316L + NYLON	POLI PVD	Or	.81							
		BLU PASTELLO	.05		LIGHT BLUE	.05		BLU PASTELLO	.05		BLEU PASTEL	.05		BLU PASTELLO	.05		BLEU PASTEL	.05		BLU PASTELLO	.05	BLEU PASTEL	.05	BLU PASTELLO	.05	BLEU PASTEL	.05	BLU PASTELLO	.05
400-NY 400-HR-NY	NYLON	BLU	.06	NYLON	BLUE	.06	NYLON	BLU	.06	NYLON	BLU	.06	ALUMINIUM LAQUE	BLEU	.06	ALUMINIUM LAQUE	GRIS	.24	ACIER INOX AISI 316L + NYLON	POLI PVD	Or	.81							
		GRIGIO	.07		GREY	.07		GRIGIO	.07		GRIS	.07		GRIGIO	.07		GRIS	.07		GRIGIO	.07	GRIS	.07	GRIGIO	.07	GRIS	.07	GRIGIO	.07
400-NY 400-HR-NY	NYLON	VERDE	.08	NYLON	GREEN	.08	NYLON	VERDE	.08	NYLON	VERDE	.08	ALUMINIUM LAQUE	VERT	.08	ALUMINIUM LAQUE	GRIS	.24	ACIER INOX AISI 316L + NYLON	POLI PVD	Or	.81							
		ROSSO	.09		RED	.09		ROSSO	.09		ROUGE	.09		ROSSO	.09		ROUGE	.09		ROSSO	.09	ROUGE	.09	ROSSO	.09	ROUGE	.09	ROSSO	.09
400-NY 400-HR-NY	NYLON	NERO	.10	NYLON	BLACK	.10	NYLON	NERO	.10	NYLON	NERO	.10	ALUMINIUM LAQUE	NOIR	.10	ALUMINIUM LAQUE	GRIS	.24	ACIER INOX AISI 316L + NYLON	POLI PVD	Or	.81							
		BIANCO	.01		WHITE	.01		BIANCO	.01		BLANC	.01		BIANCO	.01		BLANC	.01		BIANCO	.01	BLANC	.01	BIAN					

DE			* indicative farben			ES			* colores indicativos			NL			* indicatieve colors				
MATERIAL	AUSFÜHRUNG	.XX		MATERIAL	ACABADO	.XX		MATERIAAL	AFWERKINGEN	.XX									
EDELSTAHL ROSTFREI WERKSTOFF 1.4404	Standard: FEIN MATT SATINIERT	.44	■	ACERO INOXIDABLE AISI 316L	Estándar: MATE	.44	■	ROESTVAST STAAL AISI 316L	Standaard: MAT GEBORSTELD	.44	■	ROESTVAST STAAL AISI 316L +HOUT	Standaard: MAT GEBORSTELD + HOUT	.44	■	ROESTVAST STAAL AISI 316L + LEDER	Standaard: MAT GEBORSTELD + LEDER		
	Auf Anfrage: HOCHGLANZ POLIERT	.43	■		Bajo pedido: BRILLO	.43	■		Op aanvraag: BLINKEND GEBORSTELD	.43	■		Op aanvraag: BLINKEND GEBORSTELD + HOUT	.43	■		Op aanvraag: BLINKEND GEBORSTELD + LEDER	.43	■
	Auf Anfrage: PVD	.89	■		Bajo pedido: Copper Bronze Bright	.89	■		Op aanvraag: MET PVD	.89	■		Op aanvraag: BLINKEND GEBORSTELD + LEDER	.89	■		Op aanvraag: BLINKEND GEBORSTELD + LEDER	.89	■
	BESCHICHTET an sellierfen Produkten (*)	.90	■		Copper Bronze Satin Champagne Satin	.90	■		BEHANDELING voor geselecteerde Artikelen (*)	.90	■		Op aanvraag: Zwart	.90	■		Op aanvraag: Zwart	.90	■
	Black Satin	.91	■		Black Satin	.91	■		Champagne Satin	.91	■		Op aanvraag: Beige	.91	■		Op aanvraag: Beige	.91	■
Black Bright	.94	■	Black Bright	.94	■	Black Satin	.93	■	Op aanvraag: Bruin	.93	■	Op aanvraag: Bruin	.93	■					
Chocolate Satin	.95	■	Chocolate Satin	.95	■	Black Bright	.94	■	Op aanvraag: Rood	.94	■	Op aanvraag: Rood	.94	■					
Chocolate Satin	.95	■	Chocolate Satin	.95	■	Chocolate Satin	.95	■	Op aanvraag: Rood	.95	■	Op aanvraag: Rood	.95	■					
EDELSTAHL ROSTFREI WERKSTOFF 1.4404 + MASSIVHOLZ	Standard: FEIN MATT SATINIERT + MASSIVHOLZ	.46	■	ACERO INOXIDABLE AISI 316L + MADERA	Estándar: MATE + MADERA	.46	■	ALUMINIO	Estándar: ANODIZADO MATE	.66	■	ALUMINIO	Estándar: ANODIZADO MATE	.66	■	ALUMINIO	Estándar: ANODIZADO MATE		
	Auf Anfrage: HOCHGLANZ POLIERT + MASSIVHOLZ	.49	■		Bajo pedido: BRILLO + MADERA	.49	■		Bajo pedido: PINTADO	.66	■		Op aanvraag: GELAKT	.66	■		Op aanvraag: GELAKT	.66	■
	Wenge	.48	■		Wenge	.48	■		Champán	.66	■		Op aanvraag: WIT	.66	■		Op aanvraag: WIT	.66	■
	Esche	.47	■		Fresno	.47	■		Bronce	.67	■		Op aanvraag: WIT 1013	.67	■		Op aanvraag: WIT 1013	.67	■
	Mahagoni	.48	■		Caoba	.48	■		Negro	.68	■		Op aanvraag: WIT 9010	.68	■		Op aanvraag: WIT 9010	.68	■
EDELSTAHL ROSTFREI WERKSTOFF 1.4404 + LEDER	Standard: FEIN MATT SATINIERT + LEDER	.4A	■	ACERO INOXIDABLE AISI 316L + CUERO	Estándar: MATE + CUERO	.4A	■	ALUMINIO	Estándar: ANODIZADO MATE	.66	■	ALUMINIO	Estándar: ANODIZADO MATE	.66	■	ALUMINIO	Estándar: ANODIZADO MATE		
	Auf Anfrage: HOCHGLANZ POLIERT + LEDER	.3A	■		Bajo pedido: MADERA + CUERO	.3A	■		Bajo pedido: PINTADO	.66	■		Op aanvraag: Zwart	.66	■		Op aanvraag: Zwart	.66	■
	Schwarz	.4A	■		Negro	.4A	■		Champán	.66	■		Op aanvraag: WIT 1013	.66	■		Op aanvraag: WIT 1013	.66	■
	Crème	.4B	■		Beige	.4B	■		Bronce	.67	■		Op aanvraag: WIT 9010	.67	■		Op aanvraag: WIT 9010	.67	■
	Braun	.4C	■		Marrón	.4C	■		Negro	.68	■		Op aanvraag: Zilver	.68	■		Op aanvraag: Zilver	.68	■
ALUMINIUM	Standard: ELOXIERT SATINIERT	.66	■	ALUMINIO	Estándar: ANODIZADO MATE	.66	■	ALUMINIO	Estándar: ANODIZADO MATE	.66	■	ALUMINIO	Estándar: ANODIZADO MATE	.66	■	ALUMINIO	Estándar: ANODIZADO MATE		
	Auf Anfrage: LACKIERT	Ⓞ			Bajo pedido: PINTADO	Ⓞ			Bajo pedido: PINTADO	Ⓞ			Op aanvraag: Zwart	Ⓞ			Op aanvraag: Zwart	Ⓞ	
	Schwarz	.26	■		Blanco	.01	□		Blanco 1013	.20	□		Op aanvraag: WIT 1013	.20	□		Op aanvraag: WIT 1013	.20	□
	Weiss 1013	.21	□		Negro	.10	□		Bianco 9010	.30	□		Op aanvraag: WIT 9010	.30	□		Op aanvraag: WIT 9010	.30	□
	Weiss 9010	.30	□		NEGRO	.10	□		Plata	.62	■		Op aanvraag: BRUIT	.62	■		Op aanvraag: BRUIT	.62	■
NYLON	Standard: WEISS	.01	□	ALUMINIO	Estándar: ANODIZADO BRUTO	.62	■	ALUMINIO	Estándar: ANODIZADO BRUTO	.62	■	ALUMINIO	Estándar: ANODIZADO BRUTO	.62	■	ALUMINIO	Estándar: ANODIZADO BRUTO		
	Auf Anfrage: GELB	.04	■		Bajo pedido: ANODIZADO	.61	■		Bajo pedido: ANODIZADO	.61	■		Op aanvraag: Zilver	.62	■		Op aanvraag: Zilver	.62	■
	BLAU	.06	■		Plata	.62	■		Plata	.62	■		Op aanvraag: BRUIT	.62	■		Op aanvraag: BRUIT	.62	■
	GRAU	.07	■		ANODIZADO	.61	■		ANODIZADO	.61	■		Op aanvraag: Zilver	.62	■		Op aanvraag: Zilver	.62	■
	GRÜN	.08	■		BRUTO	.61	■		BRUTO	.61	■		Op aanvraag: Zilver	.62	■		Op aanvraag: Zilver	.62	■
EDELSTAHL ROSTFREI WE 1.4404	Standard: SATINIERT	.44	■	ACERO INOXIDABLE AISI 316L + NYLON	Estándar: MATE NEGRO	.44	■	ALUMINIO	Estándar: ANODIZADO Plata	.62	■	ALUMINIO	Estándar: ANODIZADO Plata	.62	■	ALUMINIO	Estándar: ANODIZADO Plata		
	Auf Anfrage: PVD	.81	■		Bajo pedido: MATE	.10	■		Bajo pedido: MATE	.10	■		Op aanvraag: Zilver	.62	■		Op aanvraag: Zilver	.62	■
	BESCHICHTET Gold	.81	■		NEGRO	.10	■		Plata	.62	■		Op aanvraag: WIT	.62	■		Op aanvraag: WIT	.62	■
	ELOXIERT	.62	■		NEGRO	.10	■		Plata	.62	■		Op aanvraag: WIT 1013	.62	■		Op aanvraag: WIT 1013	.62	■
	GRAU	.07	■		NEGRO	.10	■		Plata	.62	■		Op aanvraag: WIT 9010	.62	■		Op aanvraag: WIT 9010	.62	■
ALUMINIUM	Standard: WEISS	.01	□	ALUMINIO	Estándar: ANODIZADO BRUTO	.62	■	ALUMINIO	Estándar: ANODIZADO BRUTO	.62	■	ALUMINIO	Estándar: ANODIZADO BRUTO	.62	■	ALUMINIO	Estándar: ANODIZADO BRUTO		
	Auf Anfrage: LACKIERT	Ⓞ			Bajo pedido: ANODIZADO	.61	■		Bajo pedido: ANODIZADO	.61	■		Op aanvraag: Zilver	.62	■		Op aanvraag: Zilver	.62	■
	GRAU	.07	■		Plata	.62	■		Plata	.62	■		Op aanvraag: WIT	.62	■		Op aanvraag: WIT	.62	■
	ROTT	.09	■		ANODIZADO	.61	■		ANODIZADO	.61	■		Op aanvraag: WIT 1013	.62	■		Op aanvraag: WIT 1013	.62	■
	SCHWARZ	.10	■		BRUTO	.61	■		BRUTO	.61	■		Op aanvraag: WIT 9010	.62	■		Op aanvraag: WIT 9010	.62	■
EDELSTAHL ROSTFREI WE 1.4404 + NYLON	Standard: SATINIERT	.44	■	ACERO INOXIDABLE AISI 316L + NYLON	Estándar: MATE NEGRO	.44	■	ALUMINIO	Estándar: ANODIZADO Plata	.62	■	ALUMINIO	Estándar: ANODIZADO Plata	.62	■	ALUMINIO	Estándar: ANODIZADO Plata		
	Auf Anfrage: PVD	.81	■		Bajo pedido: MATE	.10	■		Bajo pedido: MATE	.10	■		Op aanvraag: Zilver	.62	■		Op aanvraag: Zilver	.62	■
	BESCHICHTET Gold	.81	■		NEGRO	.10	■		Plata	.62	■		Op aanvraag: WIT	.62	■		Op aanvraag: WIT	.62	■
	ELOXIERT	.62	■		NEGRO	.10	■		Plata	.62	■		Op aanvraag: WIT 1013	.62	■		Op aanvraag: WIT 1013	.62	■
	GRAU	.07	■		NEGRO	.10	■		Plata	.62	■		Op aanvraag: WIT 9010	.62	■		Op aanvraag: WIT 9010	.62	■
BESCHICHTETEM ALUMINIUM	Standard: WEISS	.30	□	ALUMINIO	Estándar: ANODIZADO BRUTO	.62	■	ALUMINIO	Estándar: ANODIZADO BRUTO	.62	■	ALUMINIO	Estándar: ANODIZADO BRUTO	.62	■	ALUMINIO	Estándar: ANODIZADO BRUTO		
	Auf Anfrage: LACKIERT	Ⓞ			Bajo pedido: ANODIZADO	.61	■		Bajo pedido: ANODIZADO	.61	■		Op aanvraag: Zilver	.62	■		Op aanvraag: Zilver	.62	■
	GRAU	.24	■		Plata	.62	■		Plata	.62	■		Op aanvraag: WIT	.62	■		Op aanvraag: WIT	.62	■
	ALUMINIUM eloxiert lichtbronz	.70	■		ANODIZADO	.61	■		ANODIZADO	.61	■		Op aanvraag: WIT 1013	.62	■		Op aanvraag: WIT 1013	.62	■
	Nylon grau	.70	■		BRUTO	.61	■		BRUTO	.61	■		Op aanvraag: WIT 9010	.62	■		Op aanvraag: WIT 9010	.62	■
ALUMINIUM ROHR ZUBEHÖRTEILE STÜTZE UND BÖGEN	Standard: ALUMINIUM eloxiert Nylon grau	.70	■	ALUMINIO TUBO ACCESORIOS SOPORTES Y CURVAS	Estándar: ALUMINIO anodizado Nylon gris	.70	■	ALUMINIO TUBO ACCESORIOS SOPORTES Y CURVAS	Estándar: ALUMINIO anodizado Nylon gris	.70	■	ALUMINIO TUBO ACCESORIOS SOPORTES Y CURVAS	Estándar: ALUMINIO anodizado Nylon gris	.70	■	ALUMINIO TUBO ACCESORIOS SOPORTES Y CURVAS	Estándar: ALUMINIO anodizado Nylon gris		
	Auf Anfrage: Lackierte Legierung metallgrau	.71	■		Lacado gris metalizado	.71	■		Lacado gris metalizado	.71	■		Op aanvraag: Zilver	.62	■		Op aanvraag: Zilver	.62	■
	ALUMINIUM eloxiert Nylon weiss	.71	■		ALUMINIO anodizado Nylon blanco	.71	■		ALUMINIO anodizado Nylon blanco	.71	■		Op aanvraag: WIT	.62	■		Op aanvraag: WIT	.62	■
	Lackierte Legierung weiss	.71	■		Lacado blanco	.71	■		Lacado blanco	.71	■		Op aanvraag: WIT 1013	.62	■		Op aanvraag: WIT 1013	.62	■
	ALUMINIUM eloxiert Nylon weiss	.71	■		ALUMINIO anodizado Nylon blanco	.71	■		ALUMINIO anodizado Nylon blanco	.71	■		Op aanvraag: WIT 9010	.62	■		Op aanvraag: WIT 9010	.62	■

PROGRAMMA 500-GSS / 500-SS / 500-CM
MATERIAI IMPIEGATI - MATERIALS - MATÉRIAUX UTILISÉS - VERWENDETE MATERIALEN - MATERIALES EMPLEADOS - GEBRUIKTE MATERIALEN
Chemical compositions of AISI stainless steel grades

Material - Stainless	C%	Cr%	Ni%	Mo%
AISI 430 (1.4016)	0,12 max	14,0-18,0	/	/
AISI 304 (1.4301)	0,08 max	18,0-20,0	8,0-10,5	/
AISI 316 (1.4401)	0,08 max	16,0-18,0	10,0-14,0	2,00-3,00
AIS 316L (1.4404)*	0,03 max	16,0-18,0	10,0-14,0	2,00-3,00

*Standard PBA

Estimated pit corrosion penetration time - time to penetrate 1 mm (years) by steel type

Location - Stainless Steel	Marine	Semi_industrial	Rural
Stainless Steel AISI 430 (1.4016)	N/A	85	250
Stainless Steel AISI 304 (1.4301)	145	135	770
Stainless Steel AISI 316 (1.4401)	260	525	1200

Source: The British Stainless Steel Association (BSSA)

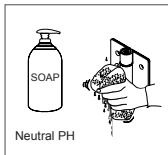

PULIZIA
MAINTENANCE
NETTOYAGE
REINIGINGSAAWIJZINGEN
LIMPIEZA
ONDERHOUD

**CERTIFICAZIONE MATERIALE - MATERIAL CERTIFICATION - CERTIFICATION DU MATÉRIEL - ZURTIFIZIERUNG DES MATERIALS
 CERTIFICACIÓN DEL MATERIAL - CERTIFIËRING VAN HET MATERIAAL**

L'acciaio usato da pba, acciaio inossidabile AISI 316L (1), garantisce il massimo grado di resistenza alla corrosione: normativa di riferimento UNI EN 1670; certificazione ottenuta dopo test di corrosione in nebbia salina secondo UNI ISO 9227.

(1) X2CrNiMo 17-12-2 secondo designazione EN 10088-3

The AISI 316L stainless steel (1) steel used by pba, meets the requirements of UNI EN 1670, the ultimate quality standard for ensuring resistance to corrosion. Pba has been awarded a certificate for successfully salt spray testing the stainless steel in accordance with UNI ISO 9227.

(1) X2CrNiMo 17-12-2 as per EN 10088-3

L'acier utilisé par pba, acier inoxydable AISI 316L (1), garantit le degré maximum de résistance à la corrosion: norme de référence UNI EN 1670; certification obtenue après un essai de corrosion par exposition à un brouillard salin conformément à UNI ISO 9227.

(1) X2CrNiMo 17-12-2 conforme à la désignation EN 10088-3

Das pba Edelstahl rostfrei Werkstoff 1.4404 (1) ist korrosionsbeständig (die höchste Stufe in Bezug auf die Norm UNI EN 1670). Die Zertifizierung wurde nach erfolgreich bestanden Korrosionstesten in Salznebel gemäß UNI ISO 9227 ausgestellt.

(1) X2CrNiMo 17-12-2 gemäss EN 10088-3

El acero utilizado por pba, acero inoxidable AISI 316L (1), garantiza el grado máximo de resistencia a la corrosión: Normativa UNI EN 1670; certificación obtenida después de una prueba de resistencia contra corrosión en atmósfera de neblinas salinas según los estándares UNI ISO 9227.

(1) X2CrNiMo 17-12-2 como en EN 10088-3

Labotests hebben aangetoond dat pba deurkrukken van de serie 400-SS in roestvast staal AISI 316L (1) een uitermate hoge roestweerstand garanderen (graad 4 - de hoogst bereikbare graad voor de Europese norm UNI EN 1670). Het certificaat wordt toegekend na weerstandstests in de zoutnevels, uitgevoerd volgens de normering UNI ISO 9227.

(1) X2CrNiMo 17-12-2 volgens de norm EN 10088-3

PROGRAMMA 500-ALU
MATERIALI IMPIEGATI - MATERIALS - MATÉRIAUX UTILISÉS - VERWENDETE MATERIELEN - MATERIALES EMPLEADOS - GEBRUIKTE MATERIELEN

Lega utilizzata di alluminio: 6060
 Trattamento superficiale: ossidazione anodica spessore 8-10 µm
 Stato metallurgico: T5

Aluminium - Legierungen: 6060
 Oberflächenbehandlung: anodische Oxydation 8-10 µm
 Werkstoffzustände: T5

Aluminium alloy employed in the manufacture of these products: 6060
 Surface treatment: anodic oxidation at a thickness of 8-10 µm
 Temper: T5

Aleación de aluminio utilizada: 6060
 Tratamiento superficial: oxidación anódica, grosor 8-10 µm
 Estados de tratamiento: T5

Alliage d' aluminium utilise: 6060
 Traitement de surface: oxydation anodique, épaisseur 8-10 µm
 Etats métallurgiques: T5

Gebruikte aluminiumlegering 6060
 Oppervlaktebehandeling: anode-oxidatie dikte 8-10 µm
 Toestandsaanduidingen: T5

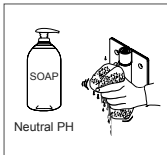

PULIZIA
MAINTENANCE
NETTOYAGE
REINIGINGSAANWIJZINGEN
LIMPIEZA
ONDERHOUD

PROGRAMMA 500-NY / 500-CM
MATERIALI IMPIEGATI - MATERIALS - MATÉRIAUX UTILISÉS - VERWENDETE MATERIELEN - MATERIALES EMPLEADOS - GEBRUIKTE MATERIELEN

- Resina termoplastica (Poliammide 6).
- Alta resistenza meccanica.
- Tenacità agli urti.
- Resistenza ad usura e abrasione.
- Classificata come autoestinguenta di categoria UL 94V-2.
 E non emana gas tossici.

- Thermoplastisches Harz (Polyamid 6):
- Hohe mechanische Widerstandsfähigkeit.
- Unzerstörbar gegenüber üblichen Schlagbeanspruchungen.
- Widerstandsfähigkeit gegen Verschleiss und Abnutzung durch Reibung.
- Selbstverlöschend in der Kategorie UL 94 V-2 klassifiziert.
 Es entstehen keine toxischen Gase.

- Thermoplastic resin (Polyamide 6).
- High mechanical resistance.
- Tenacity.
- Resistance to wear and abrasion.
- Classified as self-extinguishable into category UL 94V-2.
 It does not generate toxic gases.

- Resina de termoplástico (Poliamida 6).
- Alta resistencia mecánica.
- Resistencia contra impactos.
- Resistencia a desgaste y abrasión.
- Clasificada como auto-extinguible de clase UL 94V-2.
 Y no emana gas tóxicos.

- Résine thermoplastique (Polyamide 6).
- Résistance mécanique élevée.
- Grande résistance aux chocs.
- Résistance à l'usure et à l'abrasion.
- Classée comme auto-extinguible de catégorie UL 94V-2.
 Ne libère pas de gaz toxiques.

- POLYAMIDE 6 (thermoplastische kunststof)
- Hoge mechanische weerstand stootvast
- Gebruiksvriendelijk en onderhoudsvriendelijk
- Geklasseerd als zelfdovend onder categorie UL94V-S

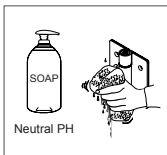

PULIZIA
MAINTENANCE
NETTOYAGE
REINIGINGSAANWIJZINGEN
LIMPIEZA
ONDERHOUD

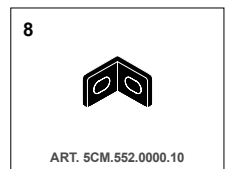
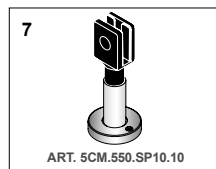
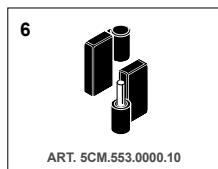
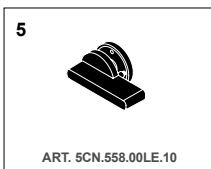
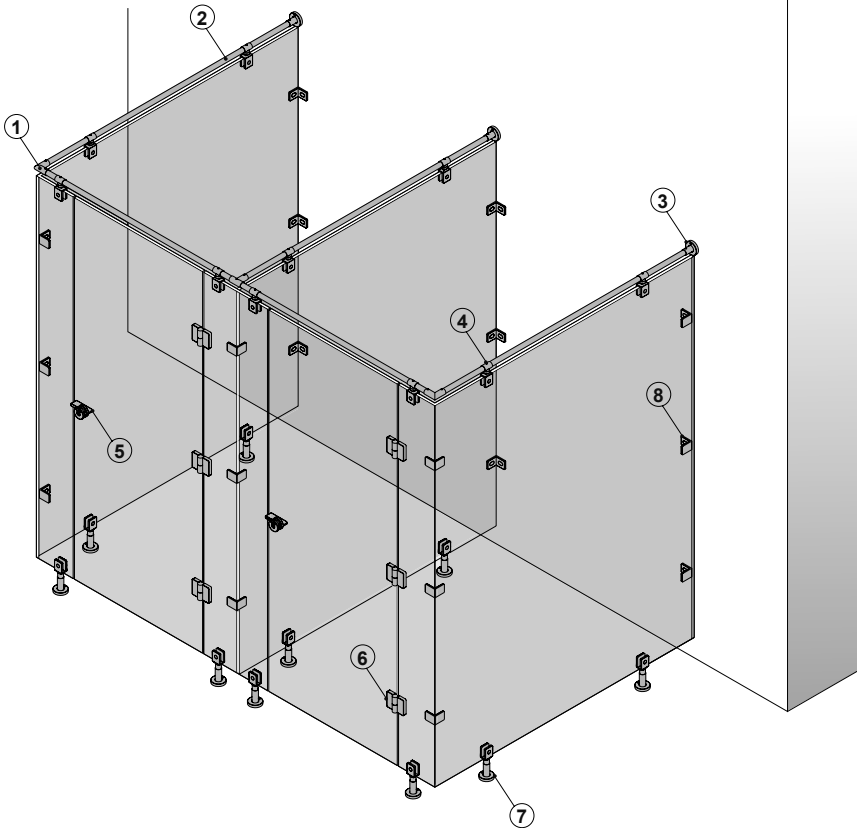
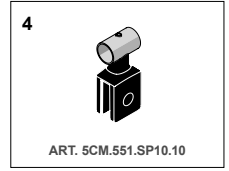
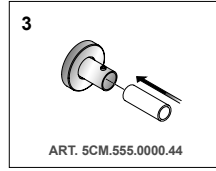
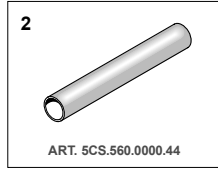
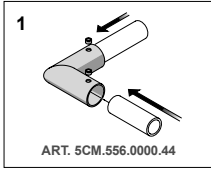

RILIEVO MISURE PER UNA CORRETTA INSTALLAZIONE DEL TUBO SUPERIORE / TAKING MEASUREMENTS FOR THE CORRECT INSTALLATION OF THE UPPER RAIL / PRISE DE MESURES POUR UNE INSTALLATION CORRECTE DU TUBE SUPERIEUR / MASSERMITTLUNG ZUR KORREKTEK INSTALLATION DES OBEREN STÜTZROHRES / TOMAR LAS MEDIDAS PARA INSTALAR CORRECTAMENTE EL TUBO SUPERIOR / AFMETINGEN VOOR EEN CORRECTE INSTALLATIE VAN DE BOVENSTE BUIS

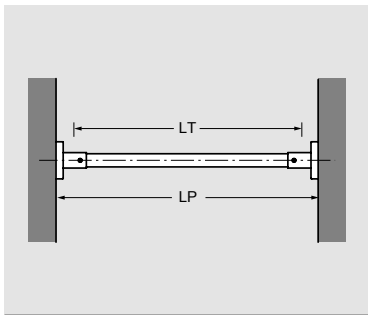

Unione Muro – Muro con articolo 5CM.555.0000
 Wall/Wall Connection with art. 5CM.555.0000
 Jonction pari-paroi avec art. 5CM.555.0000
 Verbindung Wand-Wand mit Artike 5CM.555.0000
 Unión pared-pared con artículos 5CM.555.0000
 Verbinding muur-muur met art. 5CM.555.0000

LP = Distanza tra muro e muro / Distance from wall to wall / Distance pari-paroi
 Abstand zwischen den Wänden / Distancia entre paredes / Afstand tussen de muren

LT = Lunghezza del tubo da tagliare / Length of the tube to be cut / Longueur du tube à couper / Länge des geschnittenen Rohres / Longitud del tubo a cortar / Lengte van de af te korten buis

LT = LP - 50 mm

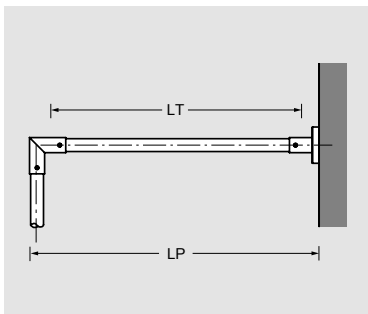

Unione ad angolo tra rosetta e curva
 Elbow connection with rose and bend
 Jonction d'angle entre la rosace et le coude
 Eckverbindung zwischen der Rosette und dem Bogen
 Unión con roseta y codo
 Hoekverbinding tussen de rozet en de bocht

LP = Distanza tra muro ed esterno tubo / Distance from wall to the end of the rail
 Distance entre la paroi et le bout du tube / Abstand zwischen Wand und Aussenrohr
 Distancia entre la pared y la extremidad del tubo / Afstand tussen de muur en het uiteinde van de buis

LT = Lunghezza del tubo da tagliare / Length of the tube to be cut / Longueur du tube à couper / Länge des geschnittenen Rohres / Longitud del tubo a cortar / Lengte van de af te korten buis

LT = LP - 59 mm

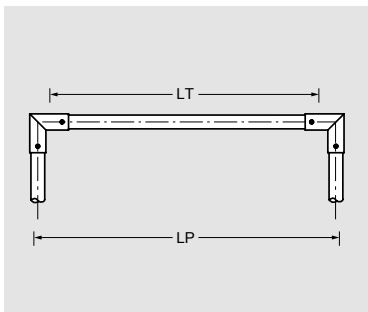

Unione tra curve
 Elbow connection with bends
 Jonction des coudes
 Verbindung zwischen den bögen
 Unión con codos
 Verbinding tussen de bochten

LP = Distanza tra i due esterno tubo / Distance between the rails / Distance entre les deux bouts du tube / Abstand zwischen den beiden Aussenrohren / Distancia entre las dos extremidades del tubo / Afstand tussen de twee uiteinden van de buis

LT = Lunghezza del tubo da tagliare / Length of the tube to be cut / Longueur du tube à couper / Länge des geschnittenen Rohres / Longitud del tubo a cortar / Lengte van de af te korten buis

LT = LP - 68 mm

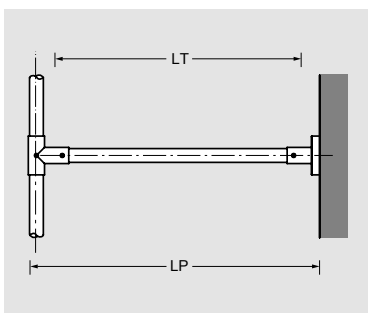

Connessione tra rosetta a muro e giunto a "T"
 Connection wall rose and T-joint
 Jonction entre la rosace sur la paroi et le joint en "T"
 Verbindung zwischen wandrosette und verbindungsselement in t-form
 Unión entre roseta de fijación en pared y unión en "T"
 Verbinding tussen de rozet en de T-koppeling

LP = Distanza tra muro ed esterno tubo / Distance from wall to rail / Distance entre la paroi et le bout du tube / Abstand zwischen der Wand und dem Aussenrohr
 Distancia entre la pared y la extremidad del tubo / Afstand tussen de muur en het uiteinde van de buis

LT = Lunghezza del tubo da tagliare / Length of the tube to be cut / Longueur du tube à couper / Länge des geschnittenen Rohres / Longitud del tubo a cortar / Lengte van de af te korten buis

LT = LP - 62 mm

pba S.p.A. Via Franco Armadori, 1 - 36056 Pozzanna su Brenta (Vicenza) Italia
e-mail: info@pba.it www.pba.it



Roselló Nº 211x 39 0 2 5 5222
08029 - BCN
936 002 002
info@arcon.es
www.arcon.es

pba Deutschland GmbH Schürmannsgraben 2 D 7 1 Moers Deutschland
e-mail: info@de.pba.it www.pba.it

pba USA, Inc. 683 3rd Street Suite C 05 Unit 20 Industry City Brooklyn NY
11232 United States e-mail: 1.212.255.605 fax: 1.646.568.0335 info@pba.usa.us