

MANUAL  
DE  
CO



ARCON

# ÍNDICE

01 MANILLAS  
PARA PUERTA

02 POMOS Y TIRADORES  
PARA MUEBLE

03 MANILLONES  
tiradores de puerta

04 ACCESORIOS  
DE BAÑO

05 TOPES DE PUERTA  
PERCHAS Y COLGADORES



DESCARGAR  
MANUAL deco

DESCARGAR  
CATÁLOGO



01  
MANILLAS  
PARA PUERTA

### H377 Steve Leung

F

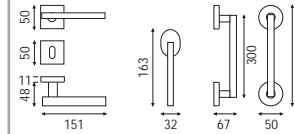

#### Acabados

Negro, Titanio, Bronce oscuro, Níquel negro y Bronce oscuro-cuero negro

### Dinamica Ivo Pellegri

C

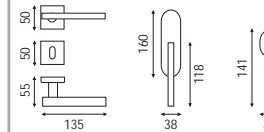

#### Acabados

Cromo mate y Antracita

### Juno Alessandro Dubini

D

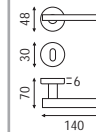

#### Acabados manilla

Cemento Ash, Dove, Antracita, Sand y Blush

#### Acabados roseta

Latón mate, Níquel mate, Cromo mate, Antracita y Negro

## Leaf

Brian Sironi

**C**

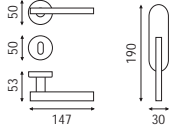

### Acabados

Antracita

## OM234

Daniel Libeskind

**E**

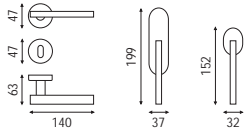

### Acabados

Cromo, Cromo mate, Inox mate y Antracita mate

## OM252

Mad Architects

**F**

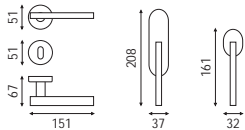

### Acabados

Cromo, Cromo mate, Inox mate, Bronce mate y Antracita mate

## 4002S5Q

**C**

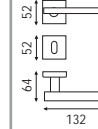

### Acabados

Antracita

## T3032Q

**B**

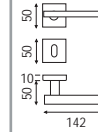

### Acabados

Titán

## OM207

Rodolfo Dordoni

**F**

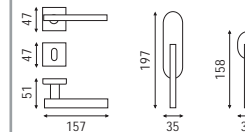

### Acabados

Cromo, Cromo mate, Inox mate, Cobre mate, Bronce mate y Antracita mate

## T4006

(B)

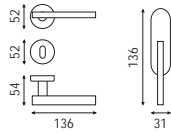

### Acabados

Titán

## Grint k

(D)

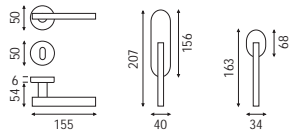

### Acabados

Cromo mate y Antracita

## T3098Q

(A)

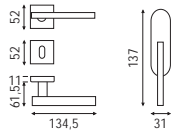

### Acabados

Titán

## OM236

Patricia Urquiola

(E)

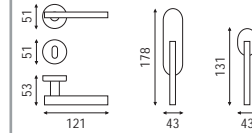

### Acabados

Cromo, Cromo mate, Inox mate, Cobre mate, Bronce mate y Antracita mate

## OM249

Oma / Rem Koolhaas

(E)

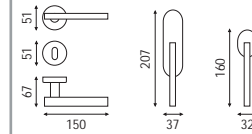

### Acabados

Cromo, Cromo mate, Cromo-Cromo mate, Inox mate, Cobre mate, Bronce mate y Antracita mate

## G214

(C)

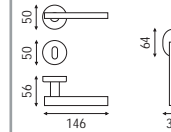

### Acabados

Grafito

## KS1 Philippe Starck

(E)

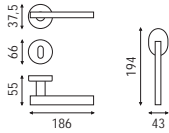

### Acabados

Cromo, Cromo mate, Nergo y Blanco

## Thelma

(C)

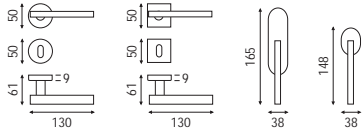

### Acabados

Negro y Blanco

## H1004

(D)

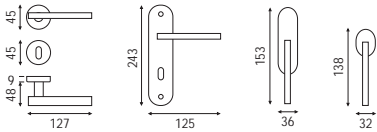

### Acabados

Latón pulido, Latón natural, Latón pulido-Porcelana blanca, Brunito, Brunito-Porcelana marfil, Patinado y Negro

## OM254 Vincent Van Duysen

(E)

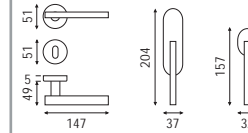

### Acabados

Cromo, Cromo mate, Inox mate, Níquel brillo, Níquel mate, Cobre mate, Bronce mate y Antracita mate

## T40065SQ

(C)

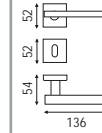

### Acabados

PVD Antracita

## T4002

(B)

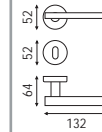

### Acabados

Negro mate

## OIT153

E

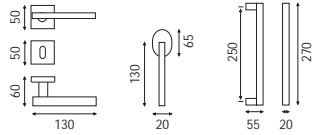

### Acabados

Inox AISI 316L lacado blanco o negro

## 2020T

D

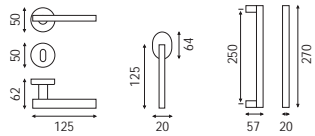

### Acabados

Inox AISI 316L lacado blanco o negro

## 2030T

D

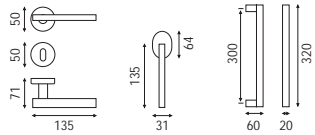

### Acabados

Inox AISI 316L lacado blanco o negro

## Blade

C

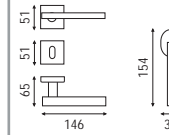

### Acabados

Negro, Blanco, Cobre brillo, Cobre satinado y London Night (bronce oscuro)

## 2030TCU

F

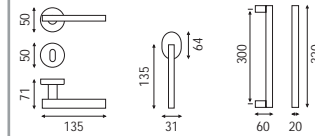

### Acabados

Inox AISI 316L lacado blanco-cuero blanco o negro cuero negro

## 2030TBLRO

Rodolfo Dordoni

D

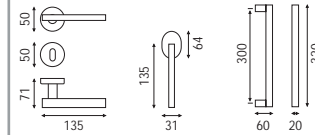

### Acabados

Inox AISI 316L lacado blanco-roble o negro-wengué

**8003R9001**  
Bjarke Ingels

(F)

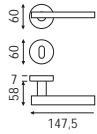

**Acabados**

Inox mate AISI 316L, Negro y Blanco

**8003R9001**  
Bjarke Ingels

(F)

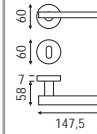

**Acabados**

Inox mate AISI 316L, Negro y Blanco

**0M501**  
GPA Monti

(A)

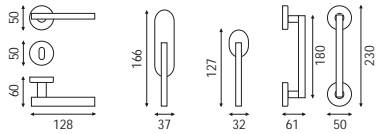

**Acabados**

Nylon Negro, Blanco y Gris

**H211**

(A)



Nylon\*

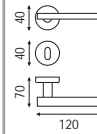

**Acabados**

Nylon Negro, Blanco, Gris, Rojo y Amarillo

**3CC.326**  
Color Therapy

(A)



Nylon\*

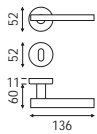

**Acabados**

Negro, Blanco, Gris, Amarillo y Rojo.

Colors Therapy: Posibilidad de combinar diferentes colores en roseta y empuñadura bajo pedido.

**H310**

Achille Castiglioni

(D)

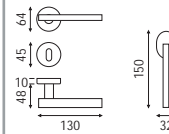

**Acabados**

Negro



## OIT153

**E**

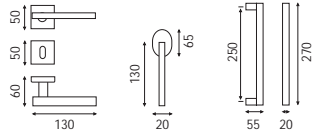

### Acabados

Inox AISI 316L lacado blanco o negro

## 2020T

**D**

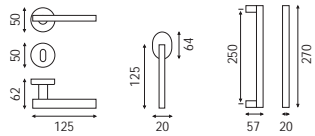

### Acabados

Inox AISI 316L lacado blanco o negro

## 2030T

**D**

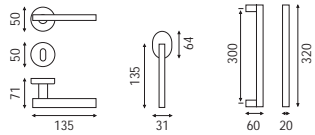

### Acabados

Inox AISI 316L lacado blanco o negro

## T2730RENG

**B**

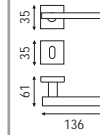

### Acabados

Negro mate y Blanco mate

## 2030TCU

**F**

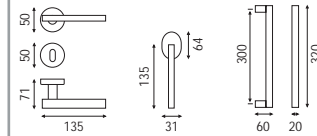

### Acabados

Inox AISI 316L lacado blanco-cuero blanco o negro cuero negro

## 2030TNGWE

Rodolfo Dordoni

**D**

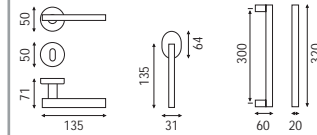

### Acabados

Inox AISI 316L lacado blanco-roble o negro-wengué

## H1008Q

D

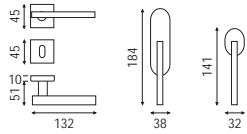

### Acabados

Cromo, Cromo mate, Latón mate, Brunito y Negro

## Thelma Q

C

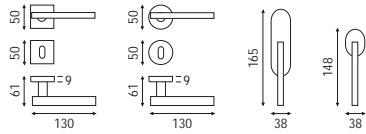

### Acabados

Negro mate y Blanco mate

## Silvyana

D

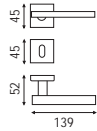

### Acabados

Negro mate

## 4071

C

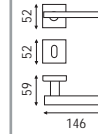

### Acabados

Negro y Titán

## H5015

Antonio Citterio

E

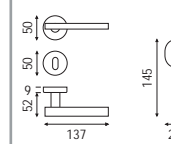

### Acabados

Negro y Bronce oscuro

## Bruges

B

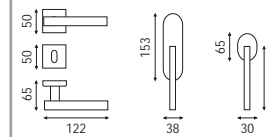

### Acabados

Negro mate

## H5008

Ricardo Bofill

D

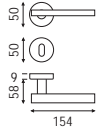

### Acabados

Cromo, Cromo mate, Latón Pulido, Latón mate y Negro

## H1008

D

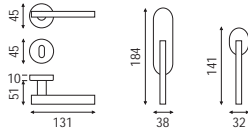

### Acabados

Cromo, Cromo mate, Latón mate, Brunito y Negro

## H5015

Antonio Citterio

F

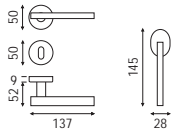

### Acabados

Inox mate, Inox brillo, Brunito y Negro

## Flow

D

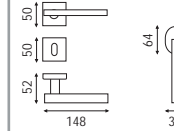

### Acabados

Cromo mate y Grafito

## 4071

C

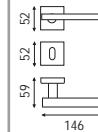

### Acabados

Negro y Titán

## Eidos

C

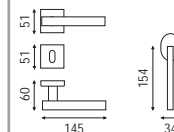

### Acabados

Negro, Blanco y Cobre brillo

## KSV

Dirk Ploos van Amstel

(F)

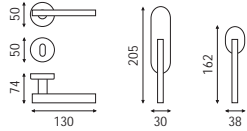

### Acabados

Acero mate-negro, Antracita-negro y Antracita-rojo

## F1102

Alessandro Mendini

(E)

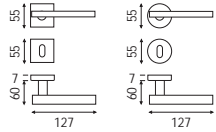

### Acabados

Aluminio-Negro, Latón pulido, Aluminio F1 e Inox mate

## K16

Marcello Cutino

(D)

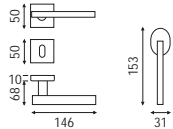

### Acabados

Cromo-Grafito y Cromo-Níquel

## H374

Franco Poli

(F)



Frontal personalizable

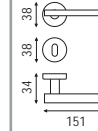

### Acabados

Cromo mate, Cromoton, Cromoton-Negro y Orsatop

## OM232

Jean Nouvel

(F)

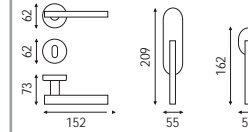

### Acabados

Cromo mate-Porcelana blanca y Cromo mate-Porcelana negra mate. Incluye tope de puerta para evitar dañar la porcelana.

## H375

Marco Triaca

(E)

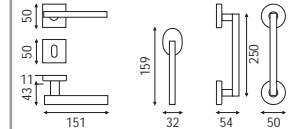

### Acabados

Blanco mate, Blanco mate-Latón pulido, Brunito, Brunito-Oro, Gris y Gris-Latón pulido

## Eidos

C

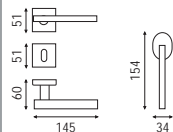

### Acabados

Cobre brillo, Blanco y Negro

## Tuke

C

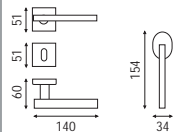

### Acabados

Cobre satinado

## Blade

C

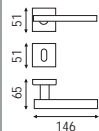

### Acabados

Negro, Blanco, Cobre brillo, Cobre satinado y London Night (bronce oscuro)

## H377

Steve Leung

F

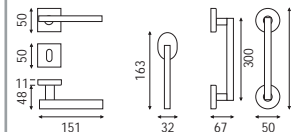

### Acabados

Negro, Titanio, Bronce oscuro, Níquel negro y Bronce oscuro-cuero negro

## F1004

David Chipperfield

F

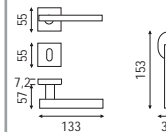

### Acabados

Inox mate, Aluminio y Bronce claro

## H1008Q

C

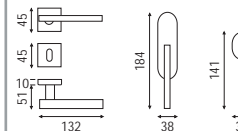

### Acabados

Cromo, Cromo mate, Latón mate, Brunito y Negro

## OM254 Vincent Van Duysen

(E)

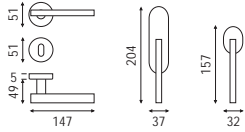

### Acabados

Cromo, Cromo mate, Inox mate, Níquel brillo, Níquel mate, Cobre mate, Bronce mate y Antracita mate

## M106 Gio Ponti

(E)

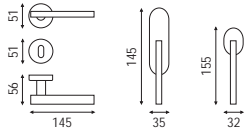

### Acabados

Cromo, Cromo mate, Inox mate, Níquel brillo, Latón pulido, Latón mate, Cobre mate, Bronce mate y Antracita mate

## H1016

(C)

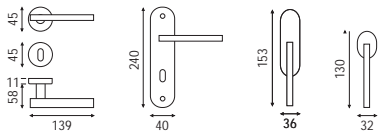

### Acabados

Cromo mate, Latón mate, Latón antiguo y Brunito

## H378 Yabu Pushelberg

(F)

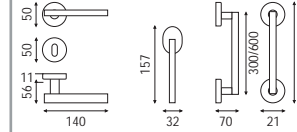

### Acabados

Bronce oscuro

## Blade

(C)

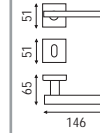

### Acabados

Negro, Blanco, Cobre brillo, Cobre satinado y London Night (bronce oscuro)

## OM237 Penta Associati

(E)

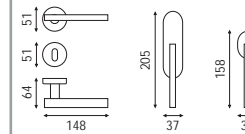

### Acabados

Cromo, Cromo mate, Inox mate y Bronce mate

## Eidos Network

Texture

D

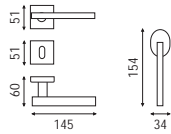

### Acabados

Cromo brillo, Latón pulido PVD, Cobre brillo, London night brillo y Antracita brillo

## Tuke Arrow

Texture

D

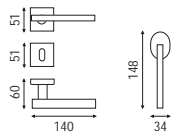

### Acabados

Cromo brillo, Latón pulido PVD, Cobre brillo, London night brillo y Antracita brillo

## Tuke Linee

Texture

D

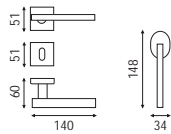

### Acabados

Cromo brillo, Latón pulido PVD, Cobre brillo, London night brillo y Antracita brillo

## Eidos Network

Texture

D

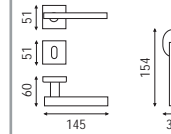

### Acabados

Cromo brillo, Latón pulido PVD, Cobre brillo, London night brillo y Antracita brillo

## Tuke Arrow

Texture

D

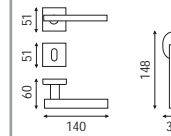

### Acabados

Cromo brillo, Latón pulido PVD, Cobre brillo, London night brillo y Antracita brillo

## Tuke Linee

Texture

D

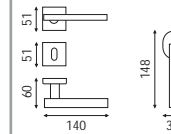

### Acabados

Cromo brillo, Latón pulido PVD, Cobre brillo, London night brillo y Antracita brillo

## OM1DD

(F)

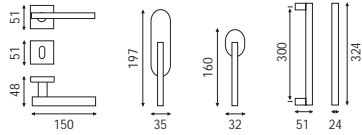

### Acabados

Como, Latón pulido y Níquel brillo

## H370

Massimiliano e Doriana Fuksas

(F)

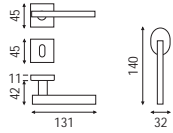

### Acabados

Cromo y Cromo mate

## OM218

Daniel Libeskind

(E)

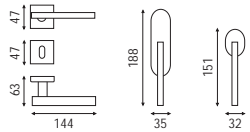

### Acabados

Cromo, Cromo mate e Inox satinado

## OM1AL

(E)

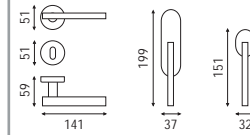

### Acabados

Como, Latón pulido y Níquel brillo

## Fusilla

Alessandro Dubini

(F)

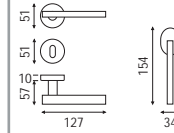

### Acabados

Cromo y Cromo mate, Latón pulido y Latón mate

## OM208

Steven Holl

(E)

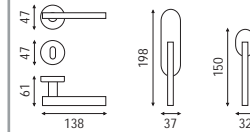

### Acabados

Cromo, Cromo mate, Inox satinado y Antracita



## H372

Eric Goshen

**E**

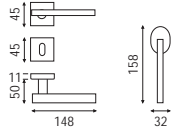

### Acabados

Cromo y Cromo mate

## H1044

Vincent Van Duysen

**C**

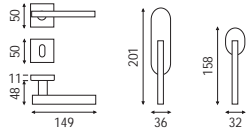

### Acabados

Cromo y Cromo mate

## H361

Antonio Citterio

**E**

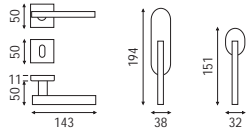

### Acabados

Cromo y Cromo mate

## H376

Giancarlo Vegni

**F**

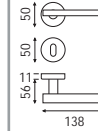

### Acabados

Cromo, Cromo mate y Cromo-Cromo mate

## H367

Giancarlo Vegni

**E**

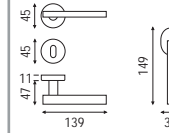

### Acabados

Cromo y Cromo mate

## H419

**A**

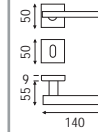

### Acabados

Inox mate

## H1045

Yoshimi Kono

(D)

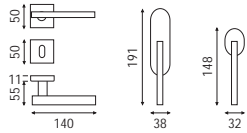

### Acabados

Cromo-Cromo mate

## H1008Q

(C)

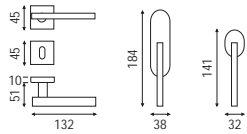

### Acabados

Cromo, Cromo mate, Latón mate, Brunito y Negro

## H364

Mario Bellini

(E)

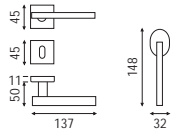

### Acabados

Cromo y Cromo mate

## H358

John Pawson

(F)

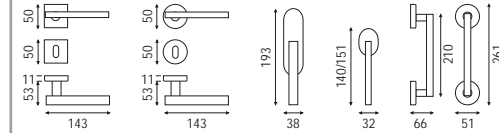

### Acabados

Cromo y Cromo mate

## H311

Mario Bellini

(F)

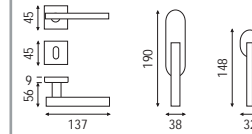

### Acabados

Cromo y Cromo mate

## H1060

Skidmore, Owings & Merrill

(E)

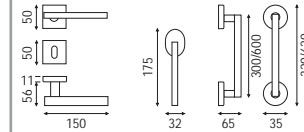

### Acabados

Cromo mate, Cromo brillo y Negro

## Dinamica

Ivo Pellegrini

**C**

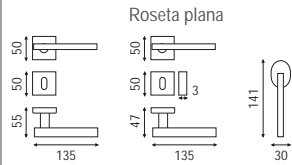

### Acabados

Cromo mate y Antracita

## Kappa

Enrico Cattaneo

**C**

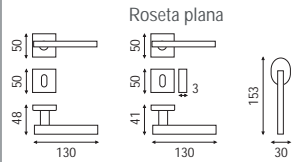

### Acabados

Cromo mate y Antracita

## G247

**C**

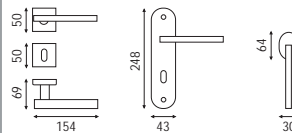

### Acabados

Cromo mate y Grafito

## OM223

Dominique Perrault

**F**

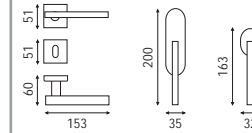

### Acabados

Cromo-cristal transparente, Cromo mate-cristal transparente. Incluye tope de puerta para evitar dañar el cristal.

## OM222

Dominique Perrault

**F**

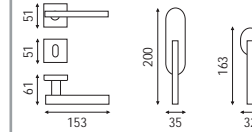

### Acabados

Cromo, Cromo mate, Inox satinado y Antracita

## OM248

Zaha Hadid

**F**

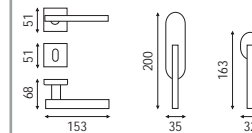

### Acabados

Cromo, Cromo mate, Bronce satinado y Antracita

## F1035

Heike Falkenberg

**C**

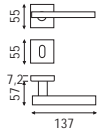

### Acabados

Aluminio F1 e Inox mate

## H354

Frank Owen Gehry

**F**

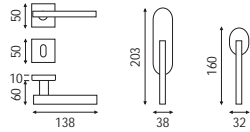

### Acabados

Cromo y Cromo mate

## T3097Q

**A**

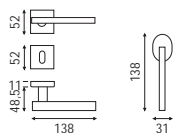

### Acabados

Níquel perla

## OM225B

Roberto Dordoni

**E**

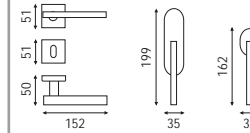

### Acabados

Cromo y Cromo mate

## F1183

Hadi Teherani

**F**

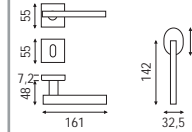

### Acabados

Aluminio e Inox mate

## F1003

Johannes Potente

**C**

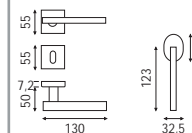

### Acabados

Aluminio F1 e Inox mate

## Cloud

C



### Cloud 2

Cromo-caucho luminiscente

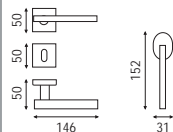

### Acabados

Cromo mate

## Sun

C

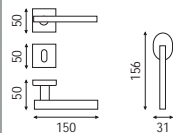

### Acabados

Cromo mate y Níquel mate

## Sun 2

C

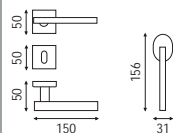

### Acabados

Cromo mate

## Milano

Ivo Pellagri

C

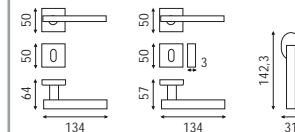

### Acabados

Cromo y Cromo mate

## Arco

BCF Studio

C

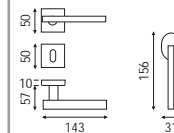

### Acabados

Cromo, Cromo mate y Latón antiguo

## KUBOCM

B

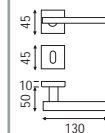

### Acabados

Cromo mate

## Riva

Lucidi Pevere

(A)

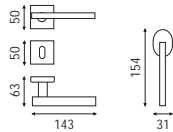

### Acabados

Cromo, Cromo mate y Níquel mate

## Arte

After Design

(C)

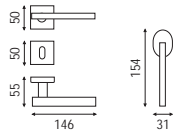

### Acabados

Cromo, Cromo mate y Latón mate

## Comet

Mauro Valsecchi

(C)

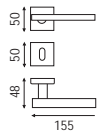

### Acabados

Cromo, Cromo mate y Latón mate

## Over

Gianfranco Melegari

(D)

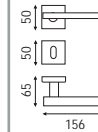
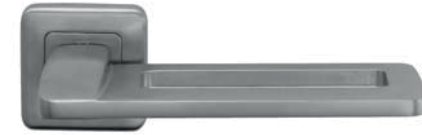

### Acabados

Cromo, Cromo mate y Latón mate

## Zenit

Gianfranco Melegari

(C)

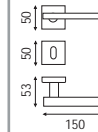

### Acabados

Cromo, Níquel mate, Latón mate y Latón pulido

## OM238Q

Javier Lopez

(D)

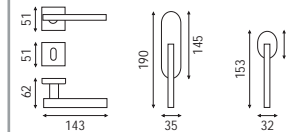

### Acabados

Cromo, Cromo mate, Inox mate y Antracita mate

## OM200 Piero Lissoni

**D**

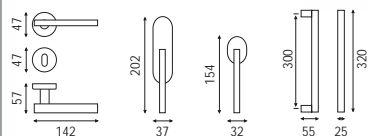

### Acabados

Cromo, Cromo mate, Inox mate, Níquel brillo, Níquel mate, Latón pulido, Cobre mate, Bronce mate y Antracita mate

## H350 Pierluigi Cerri

**F**

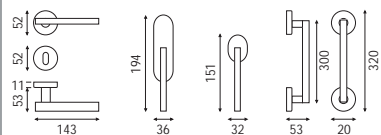

### Acabados

Cromo y Cromo mate

## H334 Foster and Partners

**F**

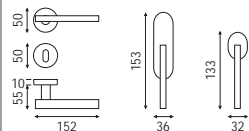

### Acabados

Cromo mate y Latón pulido

## OM232 Jean Nouvel

**F**

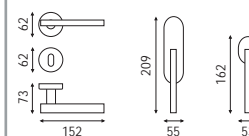

### Acabados

Cromo mate-Porcelana blanca y Cromo mate-Porcelana negra mate. Incluye tope de puerta para evitar dañar la porcelana.

## H315 Pierluigi Cerri

**D**

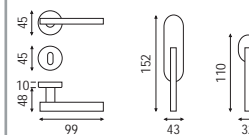

### Acabados

Cromo-Porcelana y Latón pulido-Porcelana

## OM501 GPA Monti

**A**

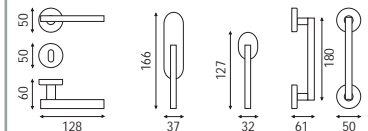

### Acabados

Nylon Negro, Blanco y Gris

## H356

Zaha Hadid

**E**

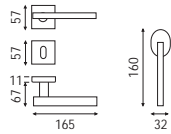

### Acabados

Cromo y Cromo mate

## H352

Odile Decq - Benoît Cornette

**F**

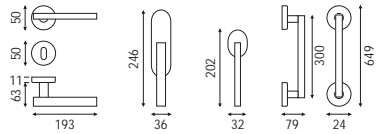

### Acabados

Cromo y Cromo mate

## H369

Eri Goshen

**E**

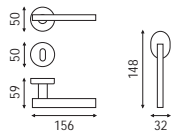

### Acabados

Cromo y Cromo mate

## H359

Skidmore, Owings & Merrill

**F**

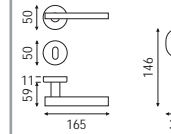

### Acabados

Cromo, Cromo mate y Bronce

## H5022

Jan Kleihues

**F**

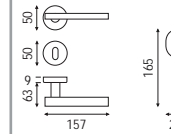

### Acabados

Inox mate

## H338

Yoshimi Kono

**D**

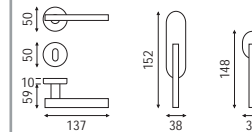

### Acabados

Cromo mate



## H335 Richard Meier

F

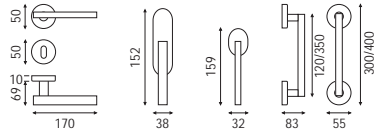

**Acabados**  
Cromo

## H5008 Ricardo Bofill

E

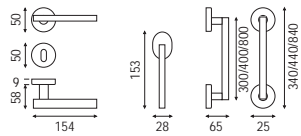

**Acabados**  
Inox mate

## 800302001 Bjarke Ingels

F

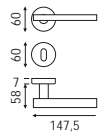

**Acabados**  
Negro, Blanco y Cromo mate

## H5021 Frank Owen Gehry

F

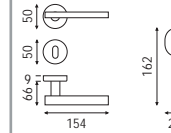

**Acabados**  
Inox mate e Inox brillo

## H5015 Antonio Citterio

F

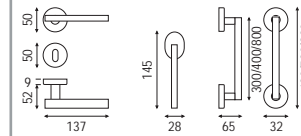

**Acabados**  
Inox mate, Inox brillo, Brunito y Negro

## H341 Hans Kollhoff

E

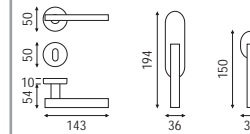

**Acabados**  
Cromo-Inox mate

## H368

Cerri & Associati

**E**

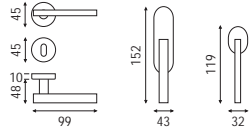

### Acabados

Cromo y Cromo mate



## K5302

**D**

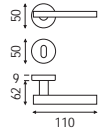

### Acabados

Inox mate



## H326

Antonio Citterio

**C**

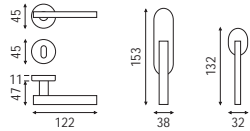

### Acabados

Cromo y Cromo mate



## H317

Antonio Citterio

**E**

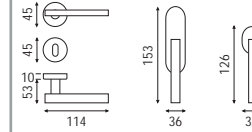

### Acabados

Cromo, Cromo mate y Latón pulido



## H327

Antonio Citterio

**D**

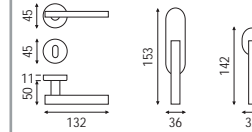

### Acabados

Cromo mate y Latón pulido



## H363

David Chipperfield

**E**

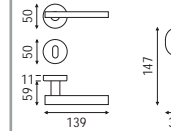

### Acabados

Cromo y Cromo mate



## OM242 Ben Van Berkel

**E**

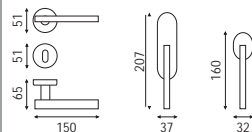

### Acabados

Cromo, Cromo mate, Inox mate, Níquel, Cobre mate, Bronce mate y Antracita mate

## OM226 Shigeru Ban

**E**

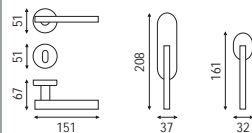

### Acabados

Cromo mate e Inox mate

## H1008

**C**

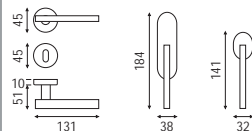

### Acabados

Cromo, Cromo mate, Latón mate, Brunito y Negro

## OM150 F. A. Porsche

**F**

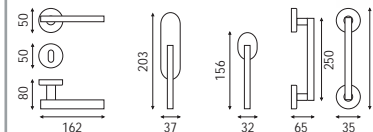

### Acabados

Cromo, Cromo mate e Inox mate

## OM231 Patricia Urquiola

**D**

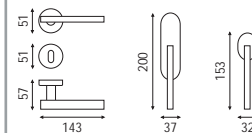

### Acabados

Cromo, Cromo mate, Níquel brillo, Cobre mate y Antracita mate

## OM182 Giorgetto Giugiaro

**D**

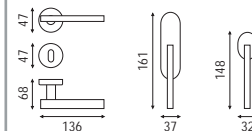

### Acabados

Cromo, Cromo mate, Níquel mate, Latón pulido, Latón mate, Inox mate y Bronce mate

## K05 Studio Enrico Baleri

C

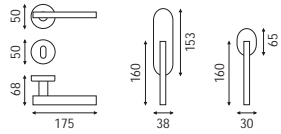

### Acabados

Policarbonato: Blanco, Negro, Rojo y Verde. Metal: Cromo, Cromo mate, Plata, Antracita, Blanco y Negro

## KS1 Philippe Starck

E

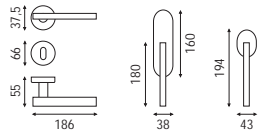

### Acabados

Cromo, Cromo mate, Plata, Antracita, Blanco y Negro

## KS2 Philippe Starck

F

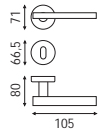

### Acabados

Cromo mate

## K01 Hannes Wettstein

E

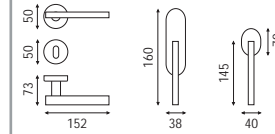

### Acabados

Cromo, Cromo mate y Latón pulido, Antracita, Blanco y Negro

## K02 Riccardo Dalisi

E

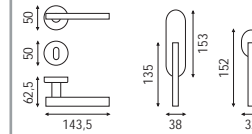

### Acabados

Cromo mate-Blanco / Aguamarina / Azul / Verde / Rosa y Latón pulido-Azul / Verde

## K15 Luigi Baroli

E

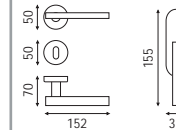

### Acabados

Cromo, Cromo mate y Antracita, con inserto Naranja, Transparente, Blanco y Negro

## Grint k

D

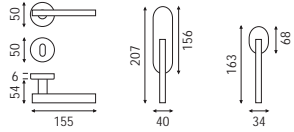

### Acabados

Cromo mate y Antracita



## DENVER

Elias Seguí

C

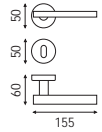

### Acabados

Cromo mate y Latón pulido



## Vieste

Ivo Pellegrini

C

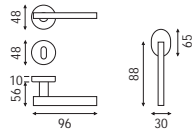

### Acabados

Cromo, Cromo mate y Negro



## Flow

C

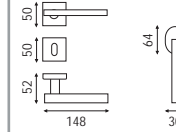

### Acabados

Cromo mate y Grafito



## OM260

Antonio Citterio

E

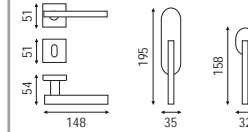

### Acabados

Cromo, Cromo mate, Inox mate, Bronce mate y Antracita mate



## OM254

Vincent Van Duysen

E

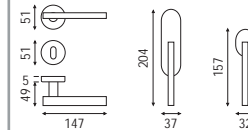

### Acabados

Cromo, Cromo mate, Inox mate, Níquel brillo, Níquel mate, Cobre mate, Bronce mate y Antracita mate



## H1050

E

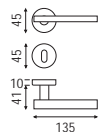
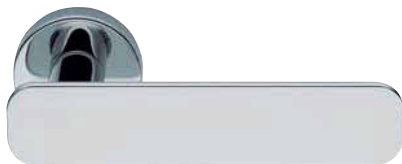

### Acabados

Cromo y Cromo mate

## K1168

E

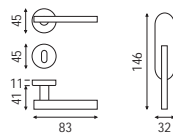

### Acabados

Cromo y Cromo mate

## ICE 4

E

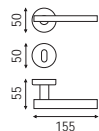

### Acabados

Cromo-piel de pez raya y Niquel-piel de pez raya

## Plus

Estudio Ecdm

D

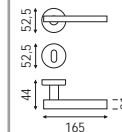

### Acabados

Inox AISI 316L mate

## OM154

Vico Magistretti

E

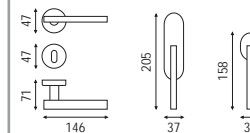

### Acabados

Cromo y Cromo mate

## OM130

D

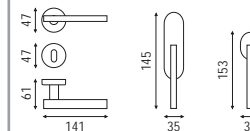

### Acabados

Cromo, Cromo mate, Inox mate y Antracita mate

## H5014

C

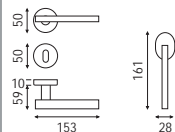

### Acabados

Inox mate

## Denver

Elias Seguí

B

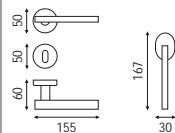

### Acabados

Cromo mate y Latón pulido

## K14

Hannes Wettstein

D

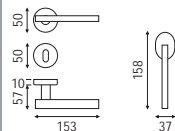

### Acabados

Cromo y Cromo mate

## Verona

B

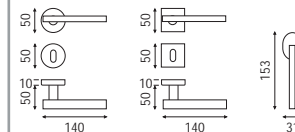

### Acabados

Cromo mate

## Horizon

Gianfranco Melegari

B

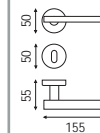

### Acabados

Cromo mate

## Sinua

Lucidi Pevere

C

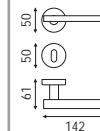

### Acabados

PVD y PDV inox

## H1039

Jean-Baptiste Sibertin Blanc

**D**

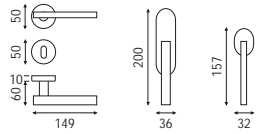

### Acabados

Cromo-Cromo mate y Latón pulido



## H348

David Chipperfield

**D**

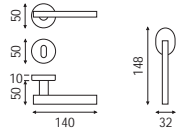

### Acabados

Cromo mate



## H1024

**C**

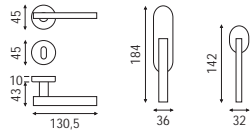

### Acabados

Cromo, Cromo mate, Latón pulido y Latón mate



## H329

Ricardo Bofill

**F**

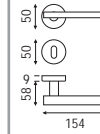

### Acabados

Cromo-cromo mate, Latón pulido-latón mate y Negro



## H1042

Panacom Architects

**E**

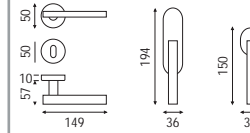

### Acabados

Cromo, Cromo mate y Latón pulido



## H330

Matteo Thun

**D**

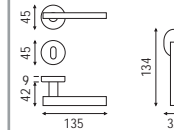

### Acabados

Cromo mate





## Siena

Mauro Doimo

A

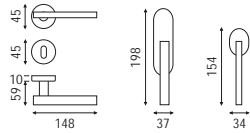

### Acabados

Níquel mate y Latón pulido

## Elba

Giovanni Amalfitano

C

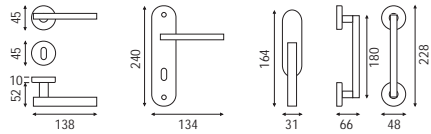

### Acabados

Cromo mate y Latón pulido

## Certosa

Maurizio Duranti

A

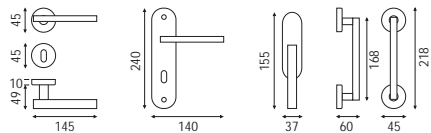

### Acabados

Cromo mate

## K13

Studio Aldo Cibic

D

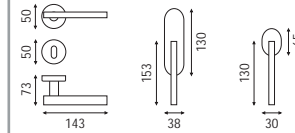

### Acabados

Cromo mate

## K09

Elias Seguí

D

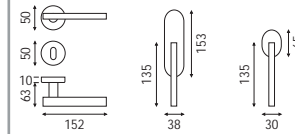

### Acabados

Cromo y Cromo-Cromo mate, Latón pulido, Latón mate, Antracita, Blanco y Negro

## K10

Elias Seguí

D

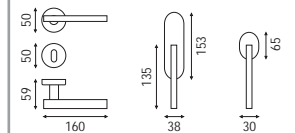

### Acabados

Cromo, Cromo-Cromo mate, Latón pulido-Latón mate, Antracita, Blanco y Negro

**F1028**  
Harmut Weise

**B**

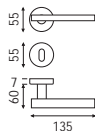

**Acabados**  
Inox mate y Aluminio F1

**F1057**  
Jan Roth

**B**

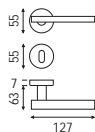

**Acabados**  
Inox mate, Aluminio F1, Latón y Bronce

**H5001**

**D**

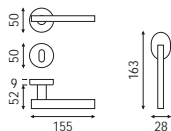

**Acabados**  
Inox mate

**F1020**  
Johannes Potente

**B**

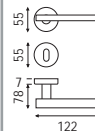

**Acabados**  
Aluminio F1, Latón y Bronce

**Asia**  
Gianfranco Melegari

**C**

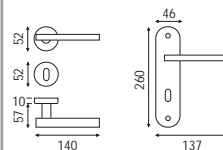

**Acabados**  
Níquel mate, Latón pulido y Latón mate

**F1027**  
Johannes Potente

**B**

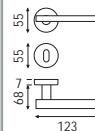

**Acabados**  
Inox mate, Aluminio F1 y Latón

## L Knud Holscher

(D)

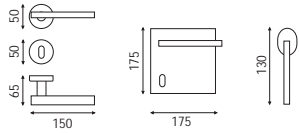

### Acabados

Inox AISI 316L mate y d line colors\*. Disponible placas de diversas medidas ø 14/16/19 mm.

## U Knud Holscher

(E)

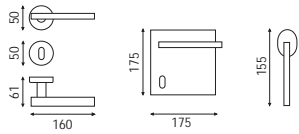

### Acabados

Inox AISI 316L mate y d line colors\*. Disponible placas de diversas medidas ø 14/16/19 mm.

## U2 Knud Holscher

(E)

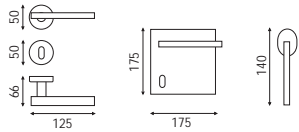

### Acabados

Inox AISI 316L mate y d line colors\*. Disponible placas de diversas medidas ø 14/16/19 mm.

## UF Knud Holscher

(E)

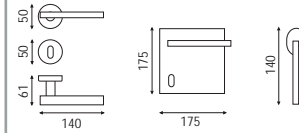

### Acabados

Inox AISI 316L mate y d line colors\*. Disponible placas de diversas medidas ø 16/19 mm.

## C Knud Holscher

(E)

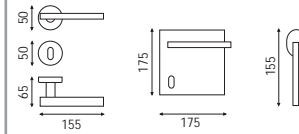

### Acabados

Inox AISI 316L mate y d line colors\*. Disponible placas de diversas medidas ø 16/19 mm.

## C2 Knud Holscher

(E)

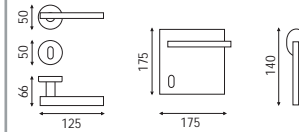

### Acabados

Inox AISI 316L mate y d line colors\*. Disponible placas de diversas medidas ø 14/16/19 mm.

## B Knud Holscher

(E)

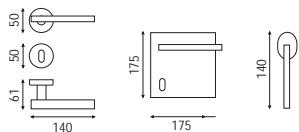

### Acabados

Inox AISI 316L mate y d line colors\*. Disponible placas de diversas medidas ø 19 mm.

## FF Knud Holscher

(E)

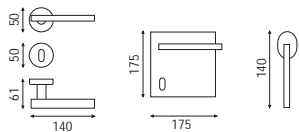

### Acabados

Inox AISI 316L mate y d line colors\*. Disponible placas de diversas medidas ø 19 mm.

## M Knud Holscher

(E)

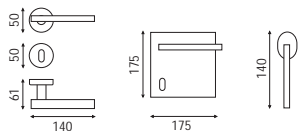

### Acabados

Inox AISI 316L mate y d line colors\*. Disponible placas de diversas medidas ø 16/19 mm.

## LF Knud Holscher

(E)

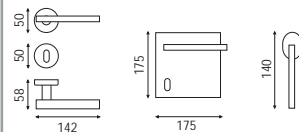

### Acabados

Inox AISI 316L mate y d line colors\*. Disponible placas de diversas medidas ø 16/19 mm.

## FFU Knud Holscher

(E)

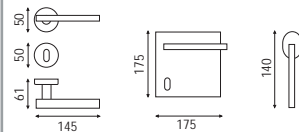

### Acabados

Inox AISI 316L mate y d line colors\*. Disponible placas de diversas medidas ø 19 mm.

## Coupe Knud Holscher

(D)

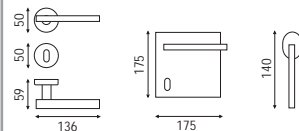

### Acabados

Inox AISI 316L mate y d line colors\*. Disponible placas de diversas medidas ø 19 mm.

## OM106

Gio Ponti

**D**

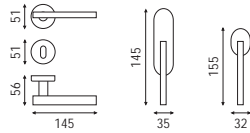

### Acabados

Cromo, Cromo mate, Inox mate, Níquel mate, Latón pulido, Latón mate, Cobre mate, Bronce mate y Antracita mate

## Megres

**C**

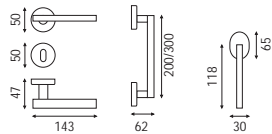

### Acabados

Inox mate-inox brillo

## Draco

**C**

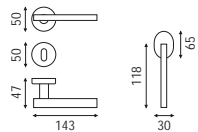

### Acabados

Inox mate-inox brillo

## F1076

Robert Mallet-Stevens

**C**

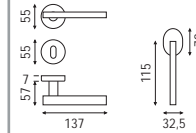

### Acabados

Inox mate, Inox brillo, Aluminio F1, Latón pulido y Bronce

## F1171

**E**

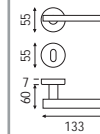

### Acabados

Inox mate

## F1102

Alessandro Mendini

**E**

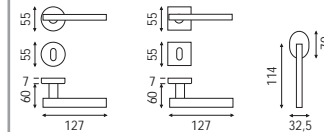

### Acabados

Inox mate, Aluminio F1, Aluminio F1-negro, Latón pulido y Bronce

## Milano

Ivo Pellegrini

C

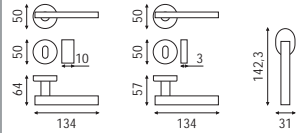

### Acabados

Cromo, Cromo mate y Latón mate

## H1038

D

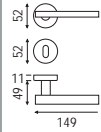

### Acabados

Cromo mate, Cromo-cromo mate y Latón pulido

## OM238

Javier Lopez

D

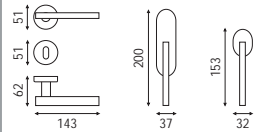

### Acabados

Cromo, Cromo mate, Inox mate, Níquel, Cobre mate, Bronce mate y Antracita mate

## OM221

Joe Colombo

D

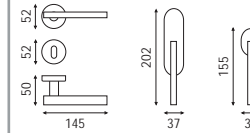

### Acabados

Cromo, Cromo mate, Inox mate y Antracita mate

## H343

John Pawson

F

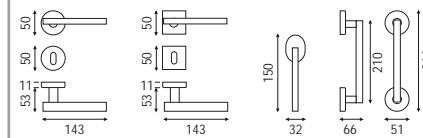

### Acabados

Cromo y Cromo mate

## OM167

Penata Associati

C

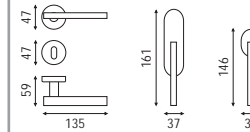

### Acabados

Cromo, Cromo mate, Latón pulido, Latón mate y Bronce mate

## OIT152

E

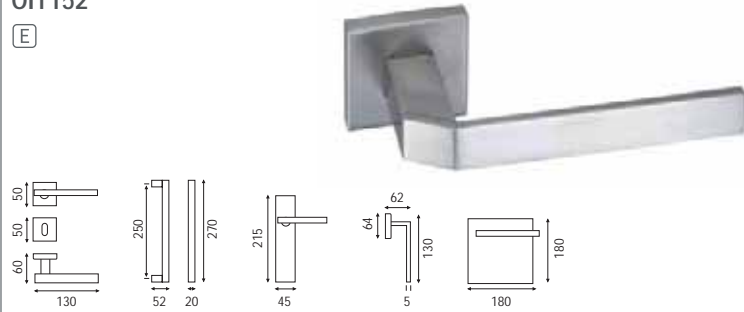

### Acabados

Inox mate AISI 316L

## OIT151

E

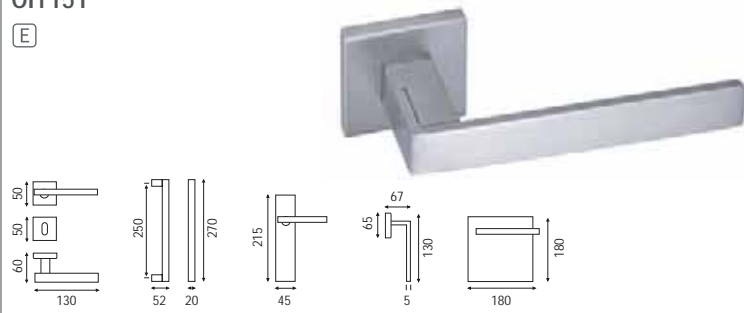

### Acabados

Inox mate AISI 316L

## OIT153

E

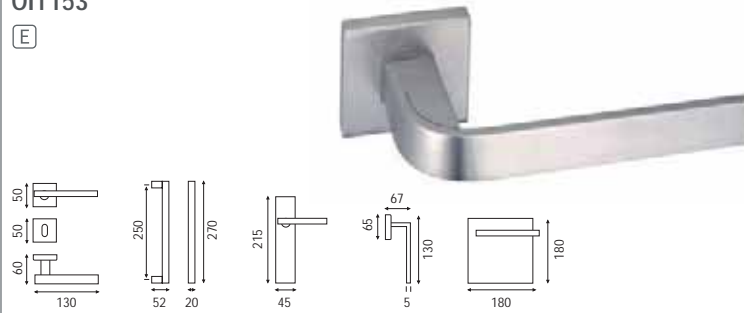

### Acabados

Inox mate AISI 316L, Blanco y Negro

## 2M1514

D

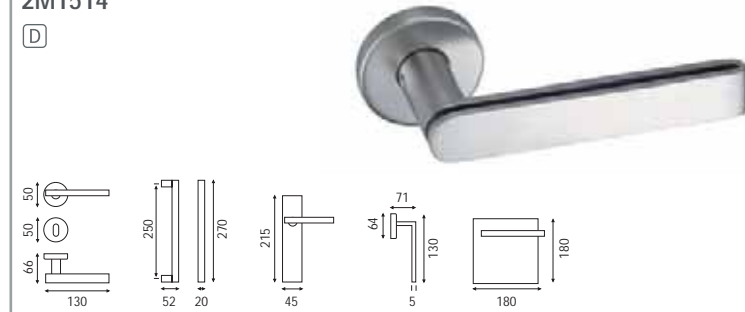

### Acabados

Inox mate AISI 316L

## 2022T

D

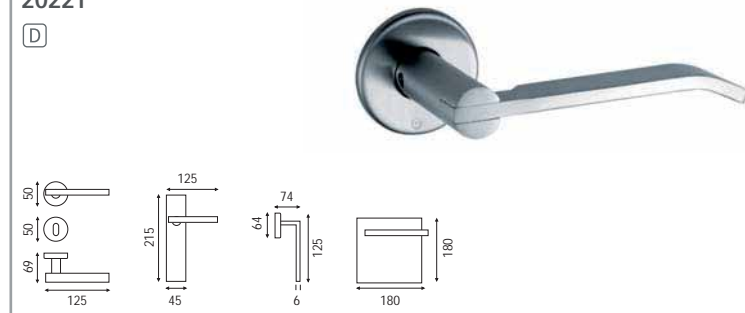

### Acabados

Inox mate AISI 316L

## 2MM172

D

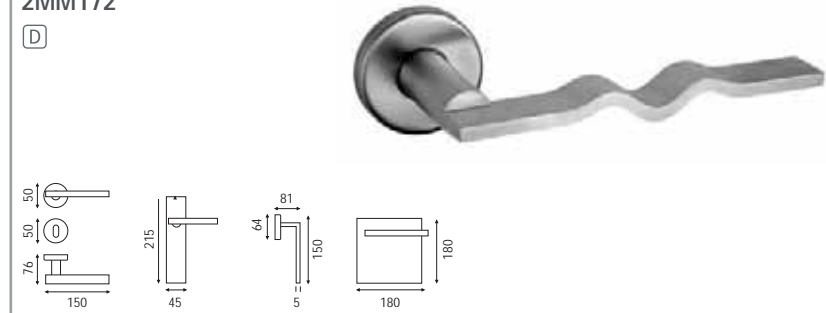

### Acabados

Inox mate AISI 316L

## 2020T

**D**

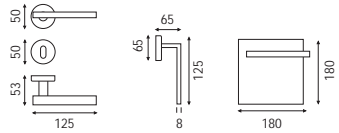

### Acabados

Inox mate AISI 316L

## 2MM171

**D**

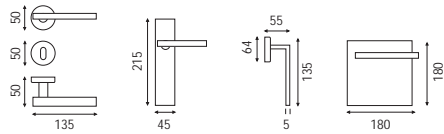

### Acabados

Inox mate AISI 316L

## OIT180

**E**



### Acabados

Inox mate AISI 316L

## 2001.IT

Tiberio Cerato y Mario Tessarollo

**F**

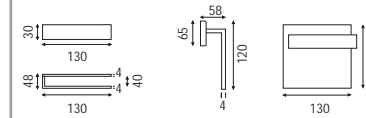

### Acabados

Inox mate AISI 316L

## 2001B.IT

Tiberio Cerato y Mario Tessarollo

**F**

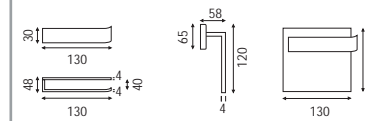

### Acabados

Inox mate AISI 316L

## OIT150

**E**

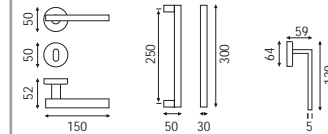

### Acabados

Inox mate AISI 316L



## 2028T

C

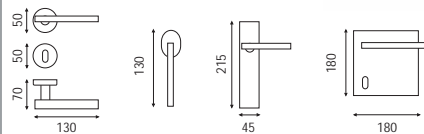

### Acabados

Inox mate AISI 316L

## 2030T

B

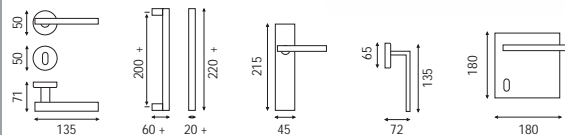

### Acabados

Inox mate AISI 316L

## 2028BT

B

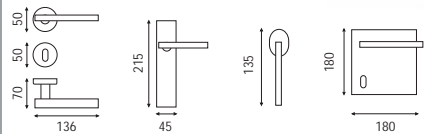

### Acabados

Inox mate AISI 316L

## 2027T

C

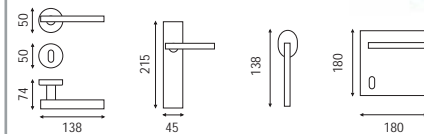

### Acabados

Inox mate AISI 316L

## 2026T

C

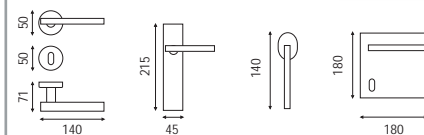

### Acabados

Inox mate AISI 316L

## 2MM029

C

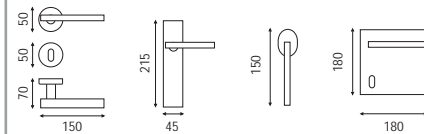

### Acabados

Inox mate AISI 316L

## STA001

E

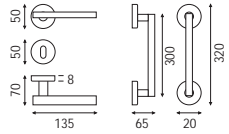

### Acabados

Inox mate AISI 316L - Aluminio Champagne/Bronce/Negro

## STA004

E

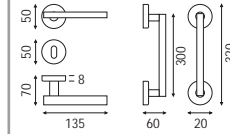

### Acabados

Inox mate AISI 316L - Aluminio Champagne/Bronce/Negro

## STA002

E

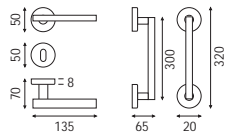

### Acabados

Inox mate AISI 316L - Aluminio Champagne/Bronce/Negro

## STA005

E

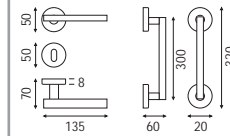

### Acabados

Inox mate AISI 316L - Aluminio Champagne/Bronce/Negro

## 2001YODCA

D

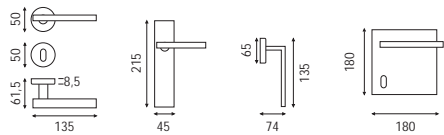

### Acabados

Inox mate AISI 316L - Madera Caoba/Haya/Wengué

## 2002YODCA

D

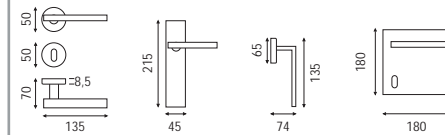

### Acabados

Inox mate AISI 316L - Madera Caoba/Haya/Wengué

## Siena

C

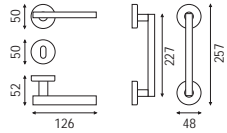

### Acabados

Níquel brillo - Madera ébano, Cromo mate - Madera ébano y Latón pulido - Madera ébano

## 2003YODCA

D

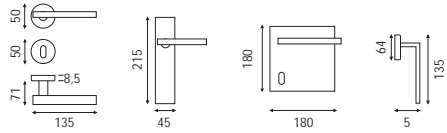

### Acabados

Inox mate AISI 316L - Madera Caoba/Haya/Wengué

## Lucia

D

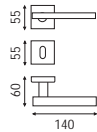

### Acabados

Madera: Cebrano, Olivo, Roble, Wengué. Roseta: Solid Surface: Blanco y Negro

## Trenta

D

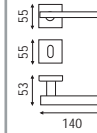

### Acabados

Madera: Cebrano, Olivo, Roble, Wengué. Empuñadura y Roseta: Solid Surface: Blanco y Negro

## Trecento

E

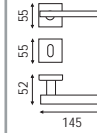

### Acabados

Madera: Cebrano, Olivo, Roble, Wengué. Empuñadura y Roseta: Solid Surface: Blanco y Negro

## Yeil

D



### Acabados

Madera: Cebrano, Olivo, Roble, Wengué

## H5015

Antonio Citterio

F

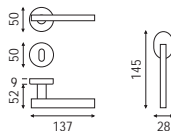

### Acabados

Inox mate - Cuero negro

## 021

C

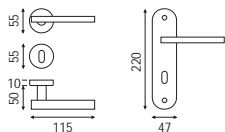

### Acabados

Aluminio F6 - Cuero marrón/marrón oscuro/blanco/piedra/negro/marfil/granate/gris/azul

## 020

D

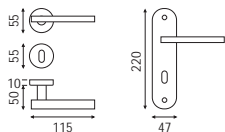

### Acabados

Aluminio F6 - Cuero marrón/marrón oscuro/blanco/piedra/negro/marfil/granate/gris/azul

## H377 CUERO

Steve Leung

F

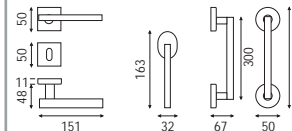

### Acabados

Negro, Titanio, Bronce oscuro, Níquel negro y Bronce oscuro-cuero negro

## ARCON CUERO

Servicio de forrado de herrajes con cuero.

Elija el manilla que más le guste y el cuero del color que prefiera.



### Acabado

En la foto: Inox mate con cuero color piedra

Colores de cuero disponibles: Cuero marrón/marrón oscuro/blanco/piedra/negro/marfil/granate/gris/azul

## 4002NGCU

D

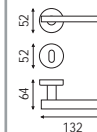

### Acabados

Negro- Cuero negro/marrón

**JN**

Jean Nouvel

**F**

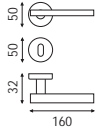

**Acabados**

Inox mate AISI 316 L - Madera Haya/Roble/Teka

**JN**

Jean Nouvel

**F**

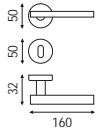

**Acabados**

Inox mate AISI 316 L - Madera Haya/Roble/Teka

**JN**

Jean Nouvel

**E**

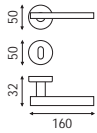

**Acabados**

Inox mate AISI 316 L

**SHL**

SHL Design

**E**

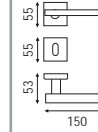

**Acabados**

Níquel mate

**AJ**

Arne Jacobsen

**F**

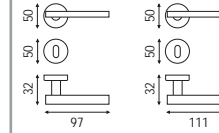

**Acabados**

Inox mate, Latón pulido y d line colors\*

**CO611**

Sergio Asti

**F**

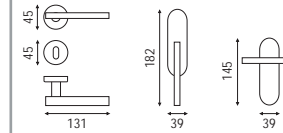

**Acabados**

Cromo, Cromo mate, Níquel, Níquel mate, Latón pulido, Latón antiguo y Oro sin barniz

480390

E

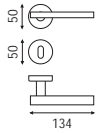

**Acabados**

Cromo, Cromo mate, Níquel, Níquel mate, Latón pulido, Latón antiguo y Oro sin barniz

480791

E

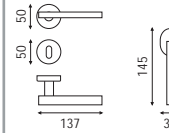

**Acabados**

Cromo, Cromo mate, Níquel, Níquel mate, Latón pulido, Latón antiguo y Oro sin barniz

C06811

Enrico Cassina

E

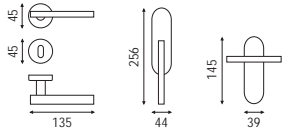

**Acabados**

Cromo, Cromo mate, Níquel, Níquel mate, Latón pulido, Latón antiguo y Oro sin barniz

C06911

Sergio Asti

E

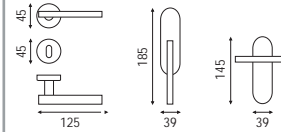

**Acabados**

Cromo, Cromo mate, Níquel, Níquel mate, Latón pulido, Latón antiguo y Oro sin barniz

C07911

Enrico Cassina

E

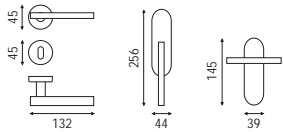

**Acabados**

Cromo, Cromo mate, Níquel, Níquel mate, Latón pulido, Latón antiguo y Oro sin barniz

C07011

Sergio Asti

E

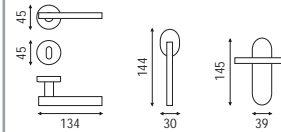

**Acabados**

Cromo, Cromo mate, Níquel, Níquel mate, Latón pulido, Latón antiguo y Oro sin barniz

## H1055 Words

Franco Poli

(E)

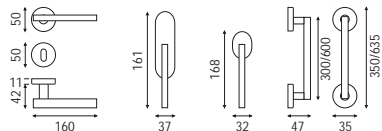

### Acabados

Cromo-negro opaco y Cromo mate-negro opaco (Personalizable)

## F1233

PMMT Arquitectos

(E)

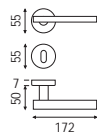

\*Braille

### Acabados

Aluminio F1 y Colores RAL

## Pop Gum

Lorenzo Susini

(E)

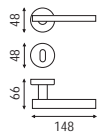

### Acabados

Cromo + funda de goma intercambiable roja, amarilla, naranja, azul, verde o gris

(\*) Pack funda colores opcional

## OM1AP

(F)

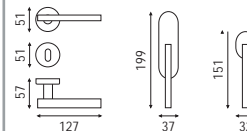
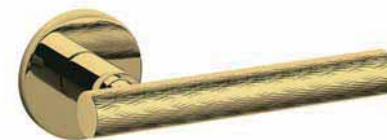

### Acabados

Cromo brillo, Níquel brillo y Latón pulido

## Fusilla

Alessandro Dubini

(F)

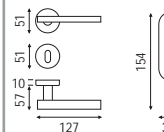

### Acabados

Cromo y Cromo mate, Latón pulido y Latón mate

## Barcelona

(F)

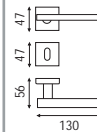

### Acabados

Cromo, Cromo mate, Níquel, Níquel mate, Latón mate y Latón pulido

## OM1DC

(F)

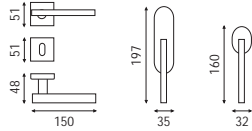

### Acabados

Cromo brillo, Níquel brillo y Latón pulido

## H329

Ricardo Bofill

(F)

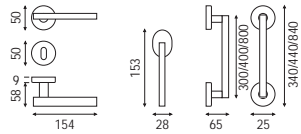

### Acabados

Cromo-cromo mate, Latón pulido-latón mate y Negro

## Siena

(C)

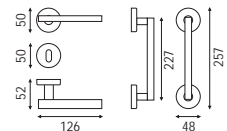

### Acabados

Níquel brillo - Madera ébano, Cromo mate - Madera ébano y Latón pulido - Madera ébano

## Romina

(B)

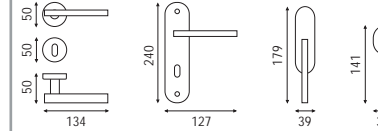

### Acabados

Cromo, Níquel mate, Latón pulido y Latón mate

## Línea

(B)

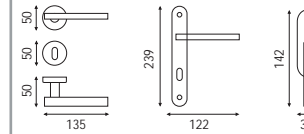
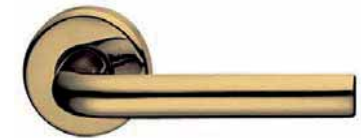

### Acabados

Cromo, Níquel mate, Latón pulido y Latón mate

## Compatta

Ivo Pellegrini

(C)

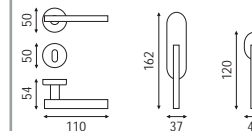

### Acabados

Cromo mate y Latón mate



## Tuke Linee

Texture

D

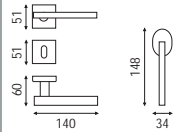

### Acabados

Cromo brillo, Latón pulido PVD, Cobre brillo, London night brillo y Antracita brillo

## H1008Q

D

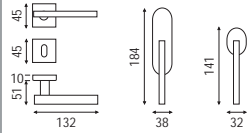

### Acabados

Cromo, Cromo mate, Latón mate, Brunito y Negro

## Comet

Mauro Valsecchi

C

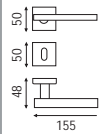

### Acabados

Cromo, Cromo mate y Latón mate

## Over

Gianfranco Melegari

D

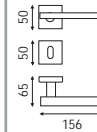

### Acabados

Cromo, Cromo mate y Latón mate

## Zenit

Gianfranco Melegari

C

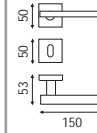

### Acabados

Cromo, Níquel mate, Latón mate y Latón pulido

## Arte

After Design

C

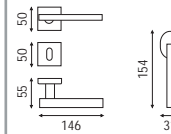

### Acabados

Cromo, Cromo mate y Latón mate

## H374

Franco Poli

(F)

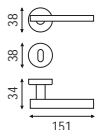

### Acabados

Cromo mate, Cromoton, Cromoton-Negro y Orsatop

## H1024

(C)

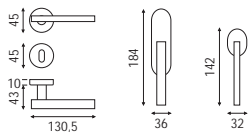

### Acabados

Cromo, Cromo mate, Latón pulido y Latón mate

## Milano

Ivo Pellegri

(C)

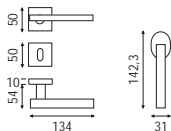
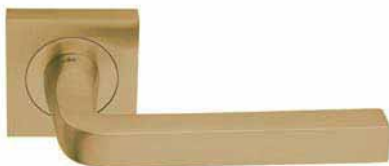

### Acabados

Cromo, Cromo mate y Latón mate

## Scan

Lucidi Pevere

(C)

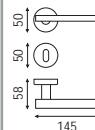

### Acabados

PVD, PVD inox

## AJ

Arne Jacobsen

(F)

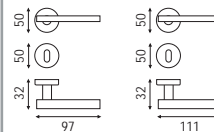

### Acabados

Inox mate, Latón pulido y d line colors\*

## H1008

(C)

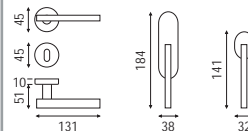

### Acabados

Cromo, Cromo mate, Latón mate, Brunito y Negro

## Katy

C

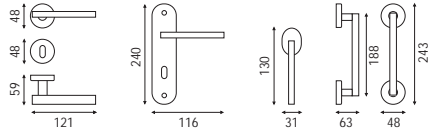

### Acabados

Latón pulido, Latón mate y Latón antiguo

## Olimpo

C

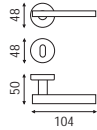

### Acabados

Cromo mate, Cromo, Latón pulido y Latón mate

## Uovo

C

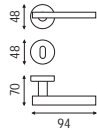

### Acabados

Cromo, Níquel mate y Latón pulido

## Elena

D

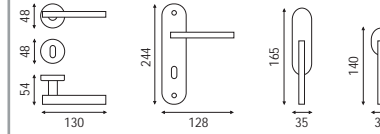

### Acabados

Latón pulido

## Thalassia

C

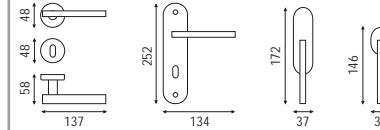

### Acabados

Latón pulido

## OM175

Nicola Novelletto

D

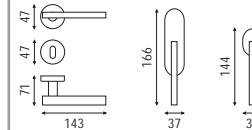

### Acabados

Cromo, Cromo mate, Inox mate, Níquel brillo, Cobre mate, Latón brillo, Latón mate y Bronce mate

## K08 Oscar Tusquets

D

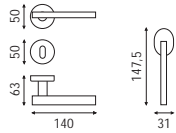

**Acabados**  
Latón mate

## H198 Studio Eero Aarnio

C

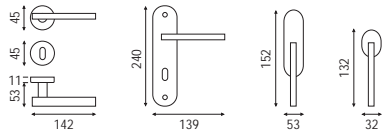

**Acabados**  
Cromo, Cromo mate, Latón pulido, Latón mate y Latón antiguo

## Asia Gianfranco Melegari

C

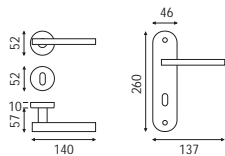

**Acabados**  
Níquel mate, Latón pulido y Latón mate

## Vento

C

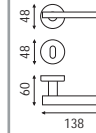

**Acabados**  
Cromo mate y Latón mate

## Onda Mauro Ronchi

C

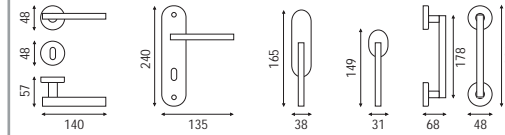

**Acabados**  
Níquel mate y Latón mate

## Goccia Mauro Ronchi

C

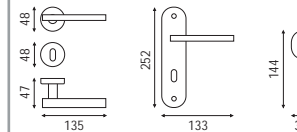

**Acabados**  
Cromo, Níquel mate, Latón pulido y Latón mate

## H1022

C

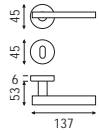

### Acabados

Cromo mate y Latón mate

## H1016

C

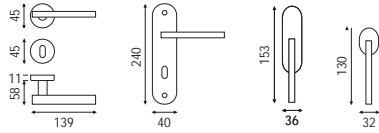

### Acabados

Cromo mate, Latón mate, Latón antiguo y Brunito

## ARCOCDLA

F

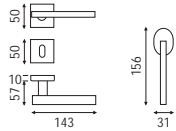

### Acabados

Cromo, Cromo mate y Latón antiguo

## H1004

D

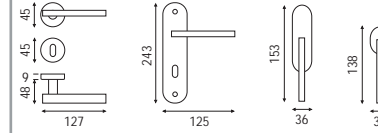

### Acabados

Latón pulido, Latón natural, Latón pulido-Porcelana blanca, Brunito, Brunito-Porcelana marfil y Patinado

## H1004

D

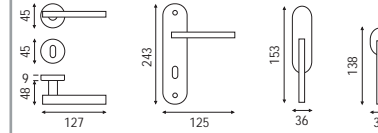

### Acabados

Latón pulido, Latón natural, Latón pulido-Porcelana blanca, Brunito, Brunito-Porcelana marfil, Patinado y Negro

## PM460

E

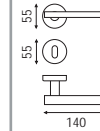

### Acabados

Bronce

## PM470

F

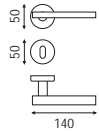

### Acabados

Latón antiguo

## PM420

E

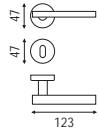

### Acabados

Plata antigua

## PM450

F

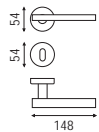

### Acabados

Latón antiguo

## Marie Louise Giuseppina

Colección Enrico Cassina

F

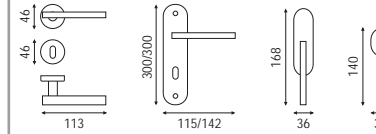

### Acabados

Latón pulido, Bronce antiguo, Bronce opaco, Latón antiguo, Oro imperial, PVD oro, PVD oro antiguo, Baño oro, PVD baño oro y Oro sin barniz

## Virginia

Colección Enrico Cassina

F

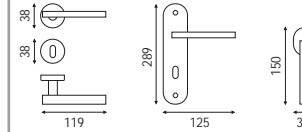

### Acabados

Latón pulido, Bronce antiguo, Bronce opaco, Latón antiguo, Oro imperial, PVD oro, PVD oro antiguo, Baño oro, PVD baño oro y Oro sin barniz

## KE03

F

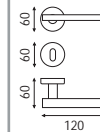

### Acabados

Cromo\*, Cromo mate\*, Níquel mate\*, Latón pulido, Latón mate\* y Brunito\*

## Batló

D

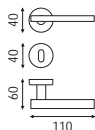

### Acabados

Latón pulido y Níquel mate

## Asia

Gianfranco Melegari

C

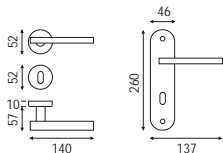

### Acabados

Latón pulido y Latón mate

## Onda

Mauro Ronchi

B

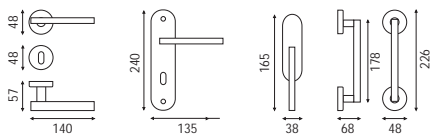

### Acabados

Níquel mate y Latón mate

## Gaudi

D

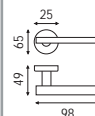

### Acabados

Latón pulido y Níquel mate

## H198

Studio Eero Aarnio

D

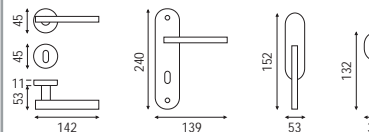

### Acabados

Cromo, Latón pulido y Latón antiguo

## Elena

D

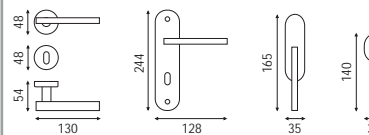

### Acabados

Latón pulido

## H1016

D

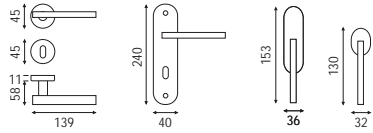

### Acabados

Cromo mate, Latón mate, Latón antiguo y Brunito



## H44

A

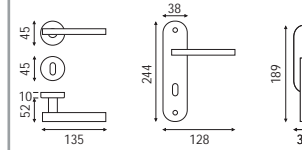

### Acabados

Cromo, Cromo mate y Oro



## H165

D

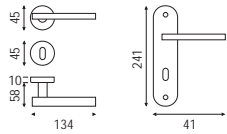

### Acabados

Latón pulido y Latón antiguo



## Katy

C

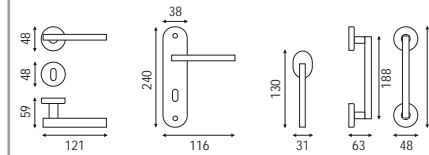

### Acabados

Latón pulido, Latón mate y Latón antiguo



## Lara

C

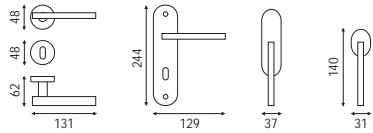

### Acabados

Latón pulido



## Lavinia

Colección Enrico Cassina

F

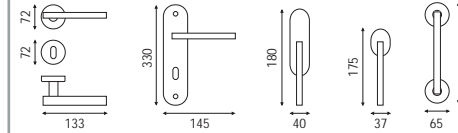



## Carlotta

Colección Enrico Cassina

F

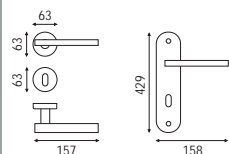

### Acabados

Latón pulido, Bronce antiguo, Bronce opaco, Latón antiguo, Oro imperial, PVD oro, PVD oro antiguo, Baño oro, PVD baño oro y Oro sin barniz

## Elisa

Colección Enrico Cassina

F

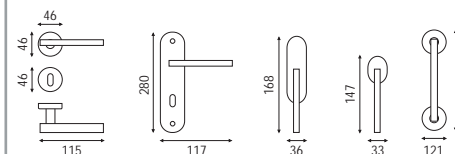

### Acabados

Latón pulido, Bronce antiguo, Bronce opaco, Latón antiguo, Oro imperial, PVD oro, PVD oro antiguo, Baño oro, PVD baño oro y Oro sin barniz

## Eleonore

Colección Enrico Cassina

D

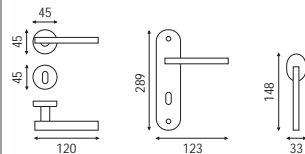

### Acabados

Latón pulido, Bronce antiguo, Bronce opaco, Latón antiguo, Oro imperial, PVD oro, PVD oro antiguo, Baño oro, PVD baño oro y Oro sin barniz

## Vittoria

Colección Enrico Cassina

F

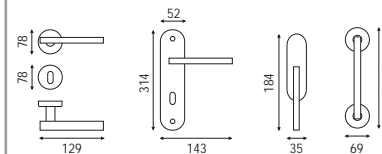

### Acabados

Latón pulido, Bronce antiguo, Bronce opaco, Latón antiguo, Oro imperial, PVD oro, PVD oro antiguo, Baño oro, PVD baño oro y Oro sin barniz

## Virginia

Colección Enrico Cassina

E

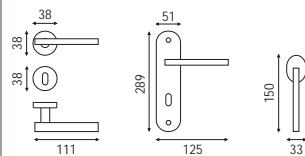

### Acabados

Latón pulido, Bronce antiguo, Bronce opaco, Latón antiguo, Oro imperial, PVD oro, PVD oro antiguo, Baño oro, PVD baño oro y Oro sin barniz

## Barbara

Colección Enrico Cassina

F

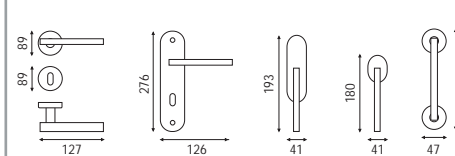

### Acabados

Latón pulido, Bronce antiguo, Bronce opaco, Latón antiguo, Oro imperial, PVD oro, PVD oro antiguo, Baño oro, PVD baño oro y Oro sin barniz

# MANILLAS PARA PUERTA

Rococò  
POP

## Marie

Colección Enrico Cassina

E

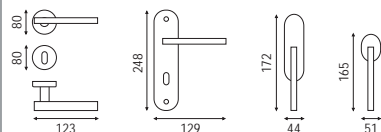

### Acabados

Latón pulido, Bronce antiguo, Bronce opaco, Latón antiguo, Oro imperial, PVD oro, PVD oro antiguo, Baño oro, PVD baño oro y Oro sin barniz



Latón pintado: Azul, Azul oscuro mate, Rojo, Amarillo, Fucsia, Verde mate, Blanco, Blanco mate, Negro y Negro mate

## Adelaide

Colección Enrico Cassina

E

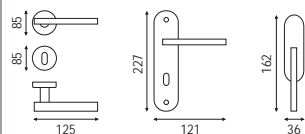

### Acabados

Latón pulido, Bronce antiguo, Bronce opaco, Latón antiguo, Oro imperial, PVD oro, PVD oro antiguo, Baño oro, PVD baño oro y Oro sin barniz



## Elisabetta

Colección Enrico Cassina

E

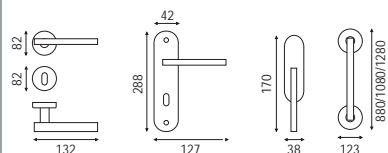

### Acabados

Latón pulido, Bronce antiguo, Bronce opaco, Latón antiguo, Oro imperial, PVD oro, PVD oro antiguo, Baño oro, PVD baño oro y Oro sin barniz



- ① C12810/5
- ② C12811
- ③ C12820
- ④ C12810DK
- ⑤ CB5180
- ⑥ CC4X4 BA
- ⑦ C52200
- ⑧ C54600

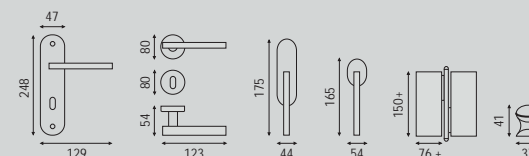

## CAS01

F

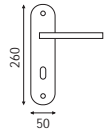

### Acabados

Cromo, Cromo mate, Níquel mate, Latón Pulido, Latón mate y Brunito

## HY01

F

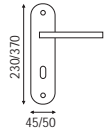

### Acabados

Cromo, Cromo mate, Níquel mate, Latón Pulido, Latón mate y Brunito

## CAS03

F

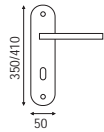

### Acabados

Cromo, Cromo mate, Níquel mate, Latón Pulido, Latón mate y Brunito

## Annelise

Colección Enrico Cassina

F

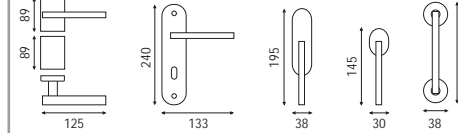

### Acabados

Latón pulido, Cromo, Cromo mate, Níquel, Níquel mate, Latón antiguo y Oro sin barniz

## Marianne

Colección Enrico Cassina

F

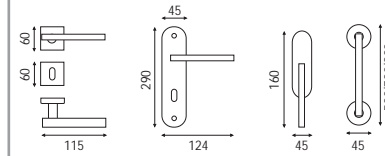

### Acabados

Latón pulido, Cromo, Cromo mate, Níquel, Níquel mate, Latón antiguo y Oro sin barniz

## Margherita

Colección Enrico Cassina

E

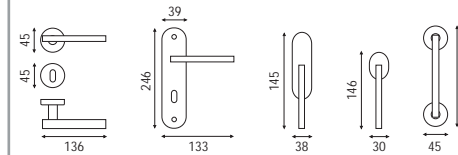

### Acabados

Latón pulido, Cromo, Cromo mate, Níquel, Níquel mate, Latón antiguo y Oro sin barniz

## Filobi

Colección Enrico Cassina

**E**

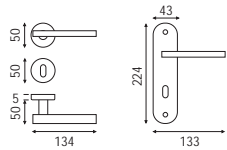

### Acabados

Latón pulido PVD, Latón mate PVD, Cromo brillo PVD, Cromo mate PVD, Negro brillo PVD y Negro mate PVD

## Barico

Colección Enrico Cassina

**E**

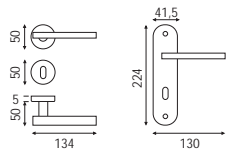

### Acabados

Latón pulido PVD, Latón mate PVD, Cromo brillo PVD, Cromo mate PVD, Negro brillo PVD y Negro mate PVD

## Soberal

Colección Enrico Cassina

**E**

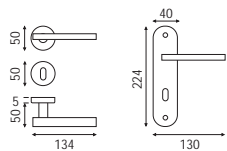

### Acabados

Latón pulido PVD, Latón mate PVD, Cromo brillo PVD, Cromo mate PVD, Negro brillo PVD y Negro mate PVD

## Filobi

Colección Enrico Cassina

**E**

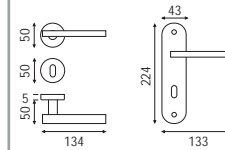

### Acabados

Latón pulido PVD, Latón mate PVD, Cromo brillo PVD, Cromo mate PVD, Negro brillo PVD y Negro mate PVD

## Barico

Colección Enrico Cassina

**E**

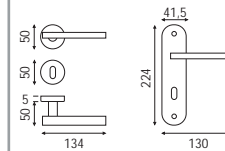

### Acabados

Latón pulido PVD, Latón mate PVD, Cromo brillo PVD, Cromo mate PVD, Negro brillo PVD y Negro mate PVD

## Soberal

Colección Enrico Cassina

**E**

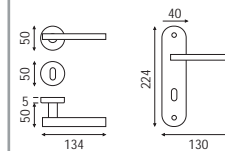

### Acabados

Latón pulido PVD, Latón mate PVD, Cromo brillo PVD, Cromo mate PVD, Negro brillo PVD y Negro mate PVD

## Andrea

C

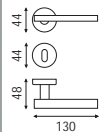

**Acabados**  
Níquel brillo

## Simona

D

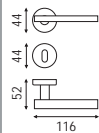

**Acabados**  
Níquel brillo

## G550

D

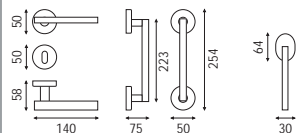

**Acabados**  
Latón pulido y Níquel mate

## Clara

D

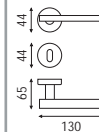

**Acabados**  
Níquel brillo

## Kuki

E

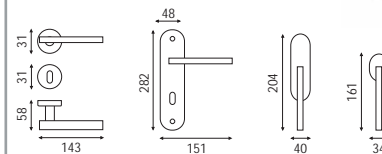

**Acabados**  
Níquel mate

## G528

D

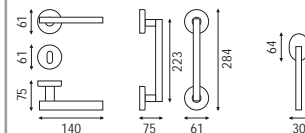

**Acabados**  
Cromo, Latón pulido y Latón antiguo

## Milano Bronze

Ivo Pellegrí

**E**

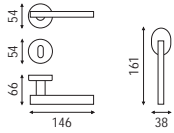

### Acabados

Bronce blanco, Bronce negro y Estaño viejo

## Arco Bronze

BCF Studio & Marcelo cutino

**E**

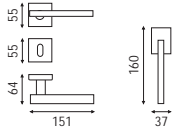

### Acabados

Bronce blanco, Bronce negro y Estaño viejo

## Milano Q Bronze

Ivo Pellegrí

**E**

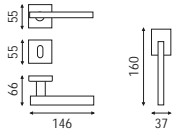
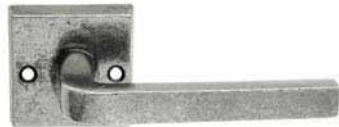

### Acabados

Bronce blanco, Bronce negro y Estaño viejo

## M152

**D**

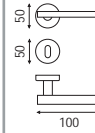

### Acabados

Fraga y Óxido

## M162

**D**

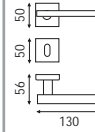

### Acabados

Fraga y Óxido

## FORJAMR

Ernest Altés

**C**

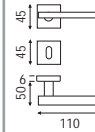

### Acabados

Forja

M172

D

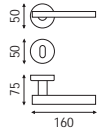

**Acabados**

Fragua y Óxido

M372

D

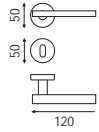

**Acabados**

Fragua y Óxido

M164

E

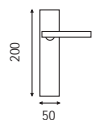

**Acabados**

Fragua y Óxido

M162

D

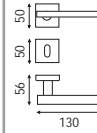

**Acabados**

Fragua y Óxido

M176

D

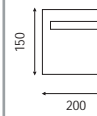

**Acabados**

Fragua y Óxido

M165

E

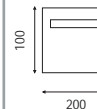

**Acabados**

Fragua y Óxido

## M172

D

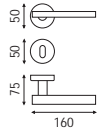

**Acabados**  
Fragua y Óxido

## GN1

D

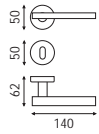

**Acabados**  
Negro y Rustik

## GN3

D

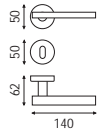

**Acabados**  
Negro y Rustik

## EDER

Simone Micheli

E



**Acabados**

Cromo, Cromo mate, Blanco, Negro, Antracita y London night mate

## EDER

Simone Micheli

E



**Acabados**

Cromo, Cromo mate, Blanco, Negro, Antracita y London night mate

## NO-HA mini

Cerradura magnética con manilla invisible

D

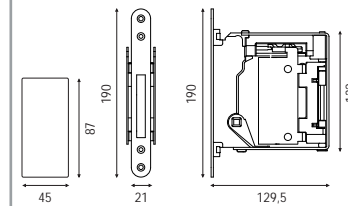

**Acabados**

Cromo mate







## MANILLAS a su GUSTO

**1**  
Elija material y acabados

**Acabados**  
Latón pulido, Envejecido antiguo, Cuero satinado, Níquel satinado, Rústico, Níquel brillo, Cromo brillo, Florencia, Envejecido manchas, Chocolate y Plata antigua

**2**  
Elija roseta o placa

Roseta

Placa

**3**  
Elija empuñadura de porcelana o latón

Porcelana

Latón



### Ejemplo de composición

- ① Acabado: Envejecido manchas
- ② Roseta: Redonda
- ② Empuñadura: Porcelana craquelé

COMPONENTES Y EJEMPLOS  
DE COMPOSICIONES

# HERRAJES ARTESANALES

Se fabrican piezas de metalistería clásica de los últimos siglos. Servicio de restauración de piezas artesanales únicas. Ofrecemos la solución ad-hoc para cada proyecto, creando la manilla que necesite.

## SUSTITUIR POMOS

Selección de manillas de diseño, pensadas exclusivamente para sustituir pomos giratorios.

En muchos edificios de viviendas, encontramos las puertas con pomos instalados. En estos casos no es posible sustituir estos pomos por manillas convencionales, puesto que el diámetro de la base del pomo es mucho mayor que el diámetro de una roseta de manilla convencional.



Rosetas con diámetro 65mm

Tubulares de 60 o 70mm de aguja

Para puertas de 35 o 45mm de grosor

### KIT ARCON



Kit de sustitución ARCON, para convertir manillas convencionales en manillas sustitución de pomo americano. Disponible en todos los acabados.



### FABRICACIÓN ARTESANAL DE HERRAJES DE METAL DE ALTA CALIDAD

Transformamos su idea en producto acabado. Manillas clásicas, llamadores, pomos clásicos, piezas modernistas, condenas y muletillas, topes de puerta, manillones, uñeros, pasadores, etc.

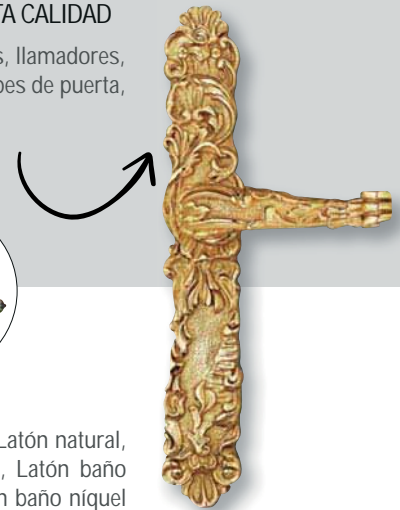
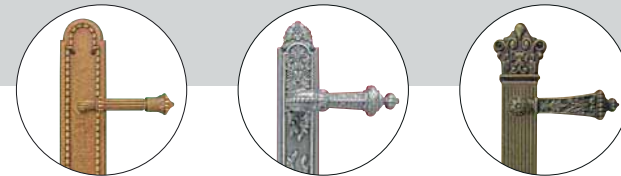

Acabados disponibles: Latón pulido y barnizado, Latón mate, Latón natural, Latón patinado, Latón color cuero, Latón baño cromo brillo, Latón baño cromo mate, Latón baño níquel satinado, Latón antiguo, Latón baño níquel bruñido, Bronce antiguo, Bronce opaco y PVD oro en distintas versiones.

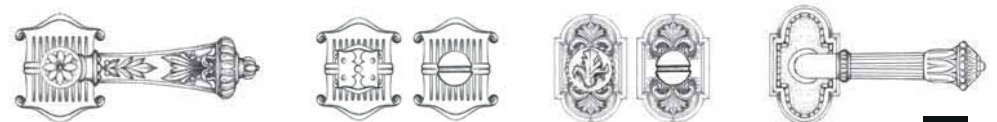

# ARCON CUERO

Servicio de forrado de herrajes con cuero. Combinamos materiales puros como el acero inoxidable, el latón o el aluminio con el cuero, en un sinfín de colores. El resultado: una fusión que dará personalidad, exclusividad y calidez a su decoración.



# 130



Blanco



Piedra



Marfil



Gris



Marrón oscuro



Granate



Negro



Marrón



Azul

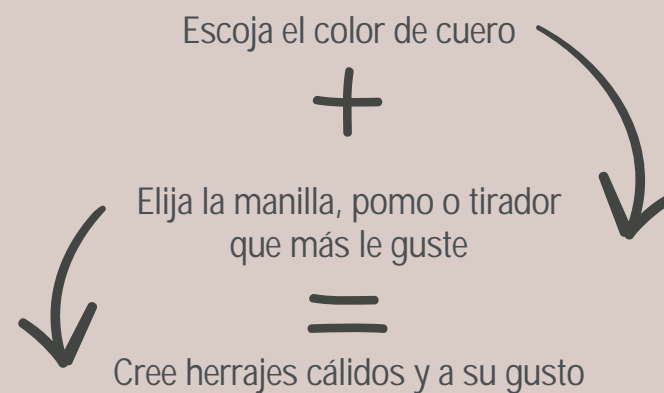

# ACCESORIOS

## BOCALLAVES, MULETILLAS/CONDENAS

Los bocallaves o embellecedores se instalan en las puertas para tapar el agujero del bombín, protegiéndolas de los rasguños de las llaves y embelleciéndolas.

Las muletillas o condenas son sistemas de cierre con botón de seguridad, para desbloquear la puerta en caso de emergencia. Pensados para proteger la privacidad en baños o habitaciones. Pueden ir equipados con registro de libre/ocupado, para baños públicos.

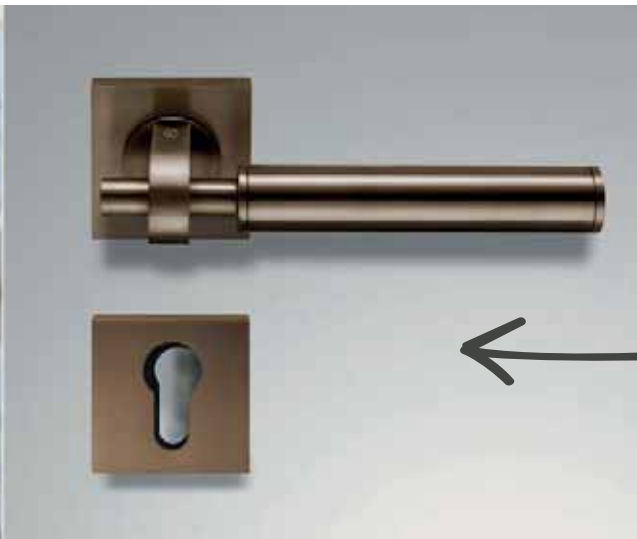

Bocallaves

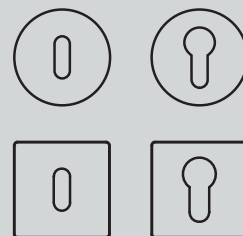

Botón exterior con o sin registro

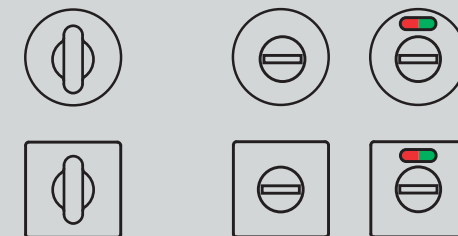

Muletillas/Condenas

Disponibles en todas las formas y acabados. Cerraduras de perfil europeo y cerraduras de gorjas. Cada manilla dispone de su conjunto de accesorios a juego.

Consulta a nuestro departamento comercial.



DESCARGAR  
CATÁLOGO



02

POMOS Y TIRADORES  
PARA MUEBLE

### GRAF2

(B)



#### Acabados

Latón mate, Simil Inox y Negro

○—○ 160 1178

←—→ 182 1200

### GRAF2 60

(A)



#### Acabados

Latón mate, Simil Inox y Negro

↑ 10

←—→ 50

### PRONTO

(B)



#### Acabados

Cromo y Negro

○—○ 128 160

←—→ 134 166

### GRAFNG

(A)



#### Acabados

Latón mate, Simil inox, Aluminio anodizado y Negro

↑ 28

○ 17,5

### TEARDROP

(B)



#### Acabados

Acero negro y Plata

○—○ 160

←—→ 180

### TEARDROP

(B)



#### Acabados

Acero negro y Plata

↑ 32

←—→ 52

42001

(B)



**Acabados**  
Negro y Blanco



42162

(A)



**Acabados**  
Negro y Blanco



17919

(B)



**Acabados**  
Negro

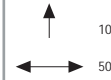

PA070ZNG

(D)



**Acabados**  
Negro

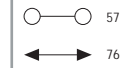

8161

(A)



**Acabados**  
Negro, Grafito, Blanco y Latón mate



8162

(A)



**Acabados**  
Negro y Blanco



151

(B)



**Acabados**  
Cromo, Cromo mate, Níquel mate, Antracita, Negro y Blanco

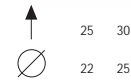

6111/6112

(A)



**Acabados**  
Cromo mate, Negro y Blanco

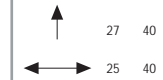

42141

(B)



**Acabados**  
Negro y Blanco



42051

(B)



**Acabados**  
Negro y Blanco



FINGER

(B)



**Acabados**  
Cromo-negro y Cromo-blanco

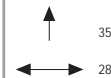

6100

(A)



**Acabados**  
Cromo mate, Negro y Blanco

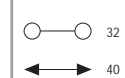

17646

(A)



**Acabados**

Transparente - negro / blanco



1452

(C)



**Acabados**

Cromo mate, Níquel mate y Negro terciopelo



529

(F)



**Acabados**

Cromo mate, Negro y Blanco

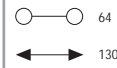

CLOUD

(B)



**Acabados**

Negro y Blanco

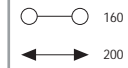

17662

(C)



**Acabados**

Transparente - negro / blanco

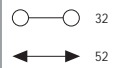

17600

(E)



**Acabados**

Transparente - negro / blanco  
Doble agujero

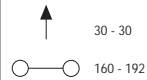

6831/6832

(A)



**Acabados**

Negro, Grafito y Blanco

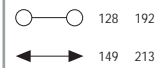

CALA

(A)



**Acabados**

Blanco

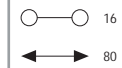

17163

(B)



**Acabados**

Cromo mate - Negro

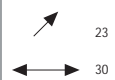

17579

(D)



**Acabados**

Cromo - blanco



A167

(B)



**Acabados**

Latón pulido, Negro y Blanco

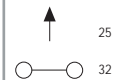

A220

(A)



**Acabados**

Negro y Rojo

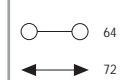

17794

**E**



**Acabados**

Negro - Cromo brillo

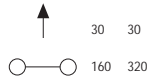

73940

**B**



**Acabados**

Cromo, Níquel mate y Negro

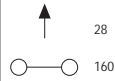

B37

**A**



**Acabados**

Cromo, Latón pulido y Negro

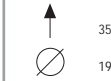

BONES

**B**



**Acabados**

Acero negro

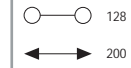

U128

**A**



**Acabados**

Latón mate y Negro

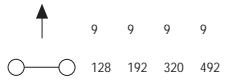

GRAF2

**B**



**Acabados**

Latón mate, Simil Inox y Negro

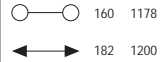

30002

**B**



**Acabados**

Cemento y Pizarra

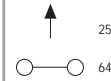

30021

**C**



**Acabados**

Cemento

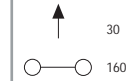

40013

**B**



**Acabados**

Negro y Blanco

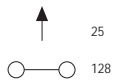

6763

**A**



**Acabados**

Grafito y Oro mate

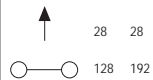

8151

**A**



**Acabados**

Grafito y Oro mate

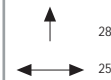

235625GR

**A**



**Acabados**

Gris

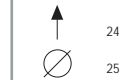



I10016

(B)



**Acabados**  
Inox mate

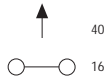

MN819

(A)



**Acabados**  
Aluminio

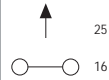

1092

(C)



**Acabados**  
Níquel mate

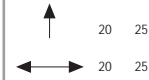

151

(B)



**Acabados**

Cromo, Cromo mate, Níquel mate, Antracita, Negro y Blanco

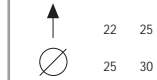

15220

(A)



**Acabados**  
Cromo y Níquel mate

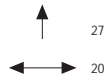

MN820

(B)



**Acabados**  
Aluminio

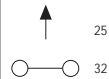

42053M

(C)



**Acabados**  
Aluminio y Aluminio mate

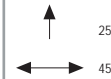

42053A

(C)



**Acabados**

Aluminio y Aluminio mate

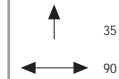

16909

(A)



**Acabados**  
Cromo mate

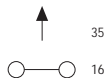

16907

(A)



**Acabados**  
Cromo mate

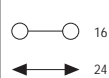

I437

(A)



**Acabados**  
Inox mate

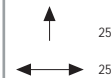

I410

(A)



**Acabados**  
Inox mate



MN751

(B)



**Acabados**

Aluminio

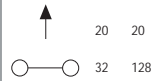

MN616

(B)



**Acabados**

Aluminio

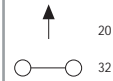

PO389

(A)



**Acabados**

Aluminio

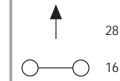

MN935

(B)



**Acabados**

Aluminio

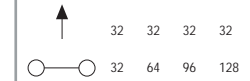

PO459

(B)



**Acabados**

Cromo y Níquel mate

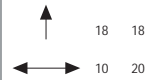

PO364

(A)



**Acabados**

Aluminio

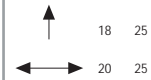

528

(B)



**Acabados**

Cromo mate, Níquel mate y Latón mate

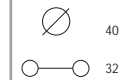

PO388

(A)



**Acabados**

Aluminio

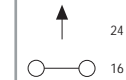

PO403

(A)



**Acabados**

Aluminio

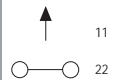

MN877

(C)



**Acabados**

Aluminio

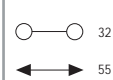

PO450 - Embutir

(E)



**Acabados**

Aluminio



580

(C)



**Acabados**

Níquel brillo, Níquel pulido y Latón mate



6100

(A)



**Acabados**

Cromo mate, Negro y Blanco

○—○ 32

↔ 40

6111/6112

(A)



**Acabados**

Cromo mate, Negro y Blanco

↑ 27 40

↔ 25 40

8830

(A)



**Acabados**

Aluminio, Cromo mate y Níquel mate

↑ 19

↔ 30

17358

(C)



**Acabados**

Cromo mate

○—○ 32

↔ 50

MN763 - Anilla móvil

(B)



**Acabados**

Aluminio

↑ 9

○—○ 24

MN795

(A)



**Acabados**

Aluminio

↑ 9

○—○ 16

16958 - Plegable

(B)



**Acabados**

Cromo mate y Níquel mate

○—○ 32

↔ 40

HOOKNM

(A)



**Acabados**

Níquel mate

↑ 20

↔ 30

113731

(A)



**Acabados**

Cromo y Simil inox

○—○ 32 64

↔ 40 76

19367

(B)



**Acabados**

Cromo, Cromo mate y Simil inox

○—○ 32

↔ 49

8080

(A)



**Acabados**

Cromo mate y Níquel mate

○—○ 16

↔ 35

1003

(A)



**Acabados**

Cromo y Simil inox

⊗ 25 35

↔ 40 60

**B242**  
Eero Aarnio  
**(B)**



**Acabados**  
Cromo y Níquel mate

↑ 28  
∅ 17

**16716**  
**(A)**



**Acabados**  
Cromo mate

↑ 24  
∅ 16

**16838**  
**(A)**



**Acabados**  
Cromo mate

↑ 28  
∅ 10

**COFFEEPOT**  
**(A)**



**Acabados**  
Cromo

↑ 23  
↔ 27,5

**16742**  
**(B)**



**Acabados**  
Cromo mate

↑ 31  
∅ 25

**I339**  
**(B)**



**Acabados**  
Inox mate

↑ 32,5 37,5 41,5  
∅ 16 20 25

**I337**  
**(B)**



**Acabados**  
Inox mate

↑ 32,5 37,5 41,5  
∅ 15 20 25

**8473**  
**(A)**



**Acabados**  
Cromo, Latón pulido y Bronce Viejo

∅ 25

**836**  
**(B)**



**Acabados**  
Inox mate e Inox brillo

↑ 22 27 32  
∅ 20 25 30

**B239**  
Gost & Schreyer  
**(B)**



**Acabados**  
Níquel mate

↑ 25  
∅ 13

**I129**  
**(B)**



**Acabados**  
Inox mate

↑ 20 25  
∅ 25 30

**3654**  
**(E)**



**Acabados**  
Aluminio F1

↑ 34  
∅ 26

**B33**  
Gregotti Associati  
**(B)**



**Acabados**  
Cromo mate, Latón pulido y Negro

↑ 25 30  
∅ 12 16

**GRAFSIN**  
**(A)**



**Acabados**  
Latón mate, Símil inox, Aluminio anodizado y Negro

↑ 26  
∅ 17,5

**42135**  
**(B)**



**Acabados**  
Aluminio satinado

↑ 15  
∅ 45

**42123/42124**  
**(B)**



**Acabados**  
Aluminio satinado

↑ 25 25  
∅ 30 35

**8921**  
**(A)**



**Acabados**  
Inox mate

∅ 13 18

**10121/10122**  
**(A)**



**Acabados**  
Cromo, Cromo mate y Níquel mate

↑ 25 28  
∅ 16 20

**17356**  
**(B)**



**Acabados**  
Cromo mate

↑ 30  
∅ 46

**17354**  
**(B)**



**Acabados**  
Cromo y Níquel mate

↑ 22  
∅ 60

**8090**  
**(A)**



**Acabados**  
Cromo, Cromo mate y Níquel mate

↑ 23  
∅ 12

**16924 / 16924 + 16926 (Base)**  
**(A)**



**Acabados**  
Cromo mate  
Base: Amarillo, Azul, Verde transparente y Negro

↑ 26      ↑ 26  
∅ 8      ∅ 20

**151**  
**(B)**



**Acabados**  
Cromo, Cromo mate, Níquel mate, Antracita, Negro y Blanco

↑ 22 25  
∅ 25 30

**3689**  
**(F)**



**Acabados**  
Aluminio F1\*

↑ 30  
∅ 33

16727

(B)



**Acabados**  
Cromo mate

○—○ 32  
↔ 85

16756

(B)



**Acabados**  
Cromo mate

↑ 23  
↔ 38

10241

(A)



**Acabados**  
Cromo\*, Cromo mate y Níquel mate

↑ 22 28  
↔ 48 60

7292/7291

(A)



**Acabados**  
Aluminio, Cromo y Níquel mate

↑ 32 64  
○—○ 50 80

CI183

(A)



**Acabados**  
Aluminio

↑ 15  
↔ 37

MN2133

(B)



**Acabados**  
Cromo

↑ 29  
↔ 50

17505

(B)



**Acabados**  
Cromo y Cromo mate

↑ 22  
○—○ 16

3691

(F)



**Acabados**  
Aluminio F1\* e Inox mate\*

↑ 29  
⊗ 30

8711/8712

(A)



**Acabados**  
Níquel mate

↑ 26 30  
↔ 32 37

B245

Eero Aarnio

(C)



**Acabados**  
Níquel mate - cromo

↑ 21  
↔ 30

113364

(A)



**Acabados**  
Cromo y Cromo mate

↑ 30  
○—○ 16

8800

(A)



**Acabados**  
Aluminio y Níquel mate

↑ 22  
↔ 30

1702016

(A)



**Acabados**  
Cromo mate

○—○ 16  
↔ 40

1702096

(B)



**Acabados**  
Cromo mate

○—○ 96  
↔ 160

PF0400  
Pininfarina

(C)



**Acabados**  
Cromo, Níquel mate, Latón pulido y Latón mate

↑ 17  
↔ 56

PF040096  
Pininfarina

(E)



**Acabados**  
Cromo mate, Níquel mate, Latón pulido y Latón mate

↑ 25  
○—○ 96

529

(F)



**Acabados**  
Cromo mate

○—○ 64  
↔ 130

MN1113  
Rodolfo Dordoni

(D)



**Acabados**  
Níquel mate

○—○ 16  
↔ 100

16225

(B)



**Acabados**  
Negro y Níquel mate

○—○ 128  
↔ 150

16423

(B)



**Acabados**  
Cromo mate

○—○ 32 64  
↔ 48 105

A240  
Eero Aarnio

(D)



**Acabados**  
Cromo

↑ 24 24  
↔ 64 96

A2050

(F)



**Acabados**  
Cromo y Níquel mate

○—○ 16

309

(C)



**Acabados**  
Níquel mate

○—○ 32  
↔ 93

MN1120  
Rodolfo Dordoni

(E)



**Acabados**  
Metal viejo

○—○ 128  
↔ 183

I421

(B)



**Acabados**

Cromo, Cromo mate y Níquel mate

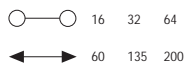

3281/3282

(A)



**Acabados**

Cromo, Cromo mate y Níquel mate



I201

(B)



**Acabados**

Inox mate

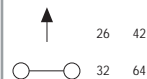

MN1109

Rodolfo Dordoni

(B)



**Acabados**

Cromo y Níquel mate



113656

(C)



**Acabados**

Cromo mate

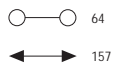

P0313

Marelli e Molteni

(A)



**Acabados**

Aluminio

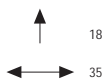

7991

(A)



**Acabados**

Níquel mate

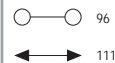

16906

(B)



**Acabados**

Níquel mate

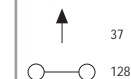

MN1112

Rodolfo Dordoni

(D)



**Acabados**

Aluminio

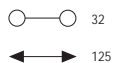

MN792

(B)



**Acabados**

Aluminio

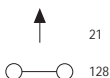

15172/15173

(A)



**Acabados**

Cromo mate y Níquel mate

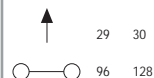

15153

(B)



**Acabados**

Níquel mate

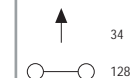



## ARCADE

C

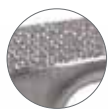

**Acabados**  
Símil Inox

○—○ 128  
↔ 144

## ARCADE

B



**Acabados**  
Símil Inox

○—○ 16  
↔ 32

## 16338

B



**Acabados**  
Níquel mate

↑ 27 30  
○—○ 128 192

## MN1121

Rodolfo Dordoni

D



**Acabados**  
Níquel mate

○—○ 128  
↔ 148

## GRAF2

B



**Acabados**  
Latón mate, Símil Inox y Negro

○—○ 160 1178  
↔ 182 1200

## GRAF2 60

A



**Acabados**  
Latón mate, Símil Inox y Negro

↑ 33  
↔ 60

## 6831/6832

A



**Acaba**  
Cromo mate, Negro, Grafito y Blanco

○—○ 128 192  
↔ 149 213

## TRIUMPH

C



**Acabados**  
Cromo

○—○ 128  
↔ 144

## TEARDROP

B



**Acabados**  
Acero negro y Plata

○—○ 160  
↔ 180

## TEARDROP

B



**Acabados**  
Acero negro y Plata

○—○ 32  
↔ 52

## I120

C



**Acabados**  
Inox mate

↑ 35 35 35 35 35 35  
○—○ 96 128 160 192 320 512

## PRONTO

B



**Acabados**  
Cromo y Negro

○—○ 128 160  
↔ 134 166

17517

C



**Acabados**

Cromo mate - Aluminio mate, Cromo mate - Cuero marrón claro / oscuro

○—○ 128 192

I110

C



**Acabados**

Inox mate

↑ 40 40 40 40 40 40  
○—○ 96 128 160 192 320 512

6771/6772

B



**Acabados**

Cromo mate y Níquel mate

○—○ 192  
←—→ 213

6770

B



**Acabados**

Cromo mate y Níquel mate

○—○ 224  
←—→ 245

6180

A



**Acabados**

Cromo y Níquel mate

↑ 7 7 7  
○—○ 32 128 192

17025

B



**Acabados**

Cromo mate

↑ 38 38  
○—○ 96 224

A2029

Giancarlo Vegni

F



**Acabados**

Cromo mate y Cromo - cromo mate

↑ 40 40 40  
○—○ 160 224 320

A2026

Marianelli e Sordina

F



**Acabados**

Cromo y Níquel mate

↑ 40 40  
○—○ 160 224

7451/7452

A



**Acabados**

Cromo mate y Níquel mate

↑ 25 25  
○—○ 64 96

6811/6812

B



**Acabados**

Cromo mate y Níquel mate

○—○ 160 224  
←—→ 230 320

I440

C



**Acabados**

Inox mate

↑ 40 40 40 40 40 40  
○—○ 96 128 192 224 320 512

MN875

C



**Acabados**

Aluminio

↑ 24 28 30  
○—○ 96 160 224

**A288**

Giancarlo Vegni

**F**



**Acabados**

Aluminio y Níquel mate



**A282**

**F**



**Acabados**

Inox mate

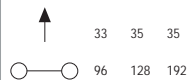

**A2025**

Antonio Citterio

**F**



**Acabados**

Inox mate

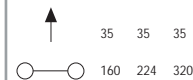

**30017**

**C**

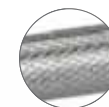

**Acabados**

Inox mate - Níquel brillo y Titanio - Níquel brillo



**I159**

**B**



**Acabados**

Inox mate

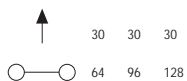

**I163**

**A**



**Acabados**

Inox mate



**7019**

**B**



**Acabados**

Inox mate



**A231**

**E**



**Acabados**

Níquel mate

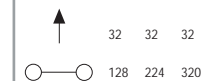

**I128**

**B**



**Acabados**

Inox mate

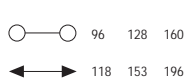

**381**

Knud Holscher

**F**



**Acabados**

Inox mate AISI 316L



**I400**

**C**



**Acabados**

Inox mate



**6765**

**A**



**Acabados**

Cromo mate y Níquel mate



**A2042**  
Frank O. Gehry

(F)



**Acabados**  
Cromo y Cromo mate

○—○ 96 128 160  
←—→ 108 149 180

**I456**

(B)



**Acabados**  
Cromo, Cromo mate y Níquel mate

↑ 28 28 28 28  
○—○ 96 128 192 320

**MN680**

(C)



**Acabados**  
Aluminio

↑ 26 26  
○—○ 128 160

**15224**

(C)



**Acabados**  
Cromo y Níquel mate

↑ 29 29  
○—○ 160 224

**7241/7242**

(A)



**Acabados**  
Aluminio y Níquel mate

○—○ 160 192  
←—→ 168 200

**I100**

(C)



**Acabados**  
Inox mate

↑ 40 40 40 40 40  
○—○ 96 128 160 192 329

**7662/7663**

(A)



**Acabados**  
Negro y Blanco

○—○ 32 96  
←—→ 71 135

**ANGLE**

(A)



**Acabados**  
Negro, Blanco y Marrón

○—○ 64 128 160 480 1440  
←—→ 100 200 200 1480 1480

**7501**

(C)



**Acabados**  
Inox mate

↑ 36 36 36 36 36 36  
○—○ 160 192 224 256 288 320

**3099**

(E)



**Acabados**  
Inox mate

↑ 24 24 24  
○—○ 96 128 160

**CURVE**

(A)



**Acabados**  
Negro y Gris

○—○ 32 128  
←—→ 45 200

**ONA**

(A)



**Acabados**  
Negro y Gris

○—○ 32 128  
←—→ 50 200

17018

(B)



**Acabados**

Aluminio

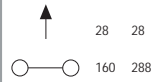

IN350

(A)



**Acabados**

Inox mate



113858

(C)



**Acabados**

Cromo y Níquel mate

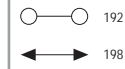

MN1106 - Embutir  
Pinuccio Borgonovo

(D)



**Acabados**

Aluminio

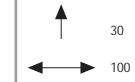

6803

(A)



**Acabados**

Cromo, Cromo mate y Níquel mate

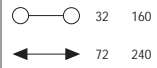

SB17224 - tirador Led

(F)



**Acabados**

Cromo y Níquel mate



MN103216AL - Embutir

(E)



**Acabados**

Aluminio

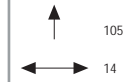

CUBIC - Embutir

(A)



**Acabados**

Negro y Blanco

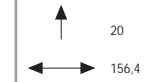

16932

(B)



**Acabados**

Aluminio



16931

(B)

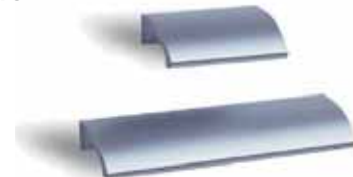

**Acabados**

Aluminio



CLOS - Embutir

(C)



**Acabados**

Cromo, Níquel mate,  
Negro y Blanco

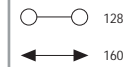

CLOS - Embutir

(C)



**Acabados**

Cromo, Níquel mate,  
Negro y Blanco

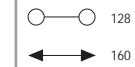

**I3040 - Adhesivos**

(E)



**Acabados**

Inox mate  
Juego de tiradores + uñero



**I3020 - Adhesivos**

(F)



**Acabados**

Inox mate  
Juego de tiradores + uñero



**I4020 - Adhesivos**

(F)



**Acabados**

Inox mate  
Juego de tiradores + uñero

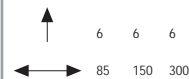

**I4010 - Adhesivos**

(F)



**Acabados**

Inox mate  
Juego de tiradores + uñero

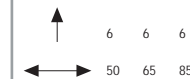

**I3010 - Adhesivos**

(D)



**Acabados**

Inox mate  
Juego de tiradores + uñero



**I4060 - Adhesivos**

(F)



**Acabados**

Inox mate  
Juego de tiradores + uñero

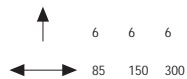

**I4050 - Adhesivos**

(F)



**Acabados**

Inox mate  
Juego de tiradores + uñero

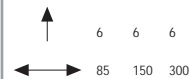

**I4503 - Embutir**

(C)



**Acabados**

Inox mate



**I3030 - Adhesivos**

(E)



**Acabados**

Inox mate  
Juego de tiradores + uñero



**I4030 - Adhesivos**

(F)



**Acabados**

Inox mate  
Juego de tiradores + uñero

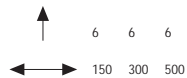

**4251- Embutir**

(F)



**Acabados**

Aluminio F1 e Inox mate

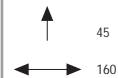

**4253 - Embutir**

(F)



**Acabados**

Aluminio F1 e Inox mate

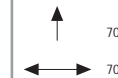

**MN503 - Embutir**

(B)



**Acabados**  
Aluminio

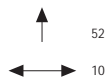

**PO2006Z - Embutir**

(F)



**Acabados**  
Aluminio

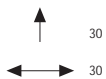

**4252 - Embutir**

(F)



**Acabados**  
Aluminio F1 e Inox mate



**I4502 - Embutir**

(C)



**Acabados**  
Inox mate



**700D - Embutir**

(B)



**Acabados**  
Aluminio satinado y Latón pulido



**588 - Embutir con anilla**

(F)



**Acabados**  
Cromo mate

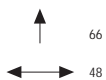

**4250 - Embutir**

(F)



**Acabados**  
Aluminio F1 e Inox mate

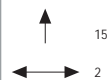

**I4504 - Embutir**

(D)



**Acabados**  
Inox mate

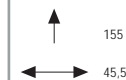

**119160 - Embutir**

(C)



**Acabados**  
Níquel mate

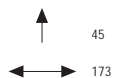

**I4250 - Embutir**

(F)



**Acabados**  
Inox mate

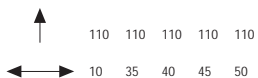

**596 - Embutir**

(C)



**Acabados**  
Cromo, Cromo mate, Níquel mate, Latón pulido, Latón mate,  
Cobre antiguo\* Negro y Blanco



**I4501 - Embutir**

(C)



**Acabados**  
Inox mate

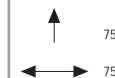

595 - Embutir

**B**



**Acabados**

Cromo, Cromo mate, Níquel mate, Latón pulido, Latón mate, Negro y Blanco

∅ 30 40 50 60 80 120

MN1116 - Embutir

**B**



**Acabados**

Aluminio

∅ 50 70

390002051 - Embutir

**F**



**Acabados**

Inox AISI 316 mate, Negro, PVD Cobre y d line colors\*

∅ 75

595 - Embutir

**B**



**Acabados**

Negro y Blanco

∅ 30 40 50

MN1114 - Embutir

James Irvine

**C**



**Acabados**

Aluminio

○—○ 128  
↔ 140

3921 - Embutir

**A**



**Acabados**

Cromo, Cromo mate, Níquel mate, Latón pulido, Bronce rústico y Blanco

↑ 36 40  
↔ 110 150

395002105 - Embutir

**F**

Knud Holscher



**Acabados**

Inox AISI 316 mate, Negro, PVD Cobre y d line colors\*

↑ 50  
↔ 100

596 - Embutir

**D**



**Acabados**

Negro y Blanco

↑ 30 40 50  
↔ 30 40 50

I420

**B**



**Acabados**

Cromo, Cromo mate y Níquel mate

↑ 55 55 55  
↔ 32 96 192

I452

**A**



**Acabados**

Cromo mate, Níquel mate y Negro terciopelo

↑ 28 28 28 28 28  
○—○ 32 96 128 192 320

MN1117 - Embutir

**B**

James Irvine



**Acabados**

Aluminio

↑ 50 70  
↔ 50 70

MN926 - Embutir

**F**



**Acabados**

Níquel mate

○—○ 64  
↔ 90



CEN3M - Embutir

(F)



Acabados  
Fragua y Óxido

∅ 90

CEN4M - Embutir

(F)



Acabados  
Fragua y Óxido

↑ 80  
↔ 80

PF2M

(D)



Acabados  
Fragua y Óxido

↑ 30  
∅ 25

PF101M

(E)



Acabados  
Fragua y Óxido

↑ 30  
↔ 20

CEN1M - Embutir

(F)



Acabados  
Fragua y Óxido

↑ 205  
↔ 50

CEN2M - Embutir

(F)



Acabados  
Fragua y Óxido

↑ 155  
↔ 45

322010X/32101FRA

(B)



Acabados  
Fragua y Óxido

↑ 25  
↔ 40

202050X/20105FRA

(C)



Acabados  
Fragua y Óxido

○ 175  
↔ 210

4250BR - Embutir

(F)



Acabados  
Bronce claro

↑ 155  
↔ 39

4251BR - Embutir

(F)



Acabados  
Bronce claro

↑ 155  
↔ 30

FORJAPLA Ernest Altés

(F)



Acabados  
Forja\*

↑ 45  
↔ 55

FORJAESP Ernest Altés

(F)



Acabados  
Forja\*

↑ 45  
↔ 55

20003FRA

**B**



**Acabados**  
Fragua

○—○ 82

←—→ 97

20003OX

**B**



**Acabados**  
Óxido

○—○ 82

←—→ 97

420

**C**



**Acabados**  
Latón antiguo

○—○ 75 95

←—→ 102 130

465

**C**



**Acabados**  
Latón antiguo

○—○ 80 100

←—→ 82 102

448

**E**



**Acabados**  
Latón antiguo

○—○ 64

←—→ 100

937

**C**



**Acabados**  
Latón envejecido

○—○ 64

←—→ 97

908

**A**



**Acabados**  
Latón envejecido

∅ 23 33 40

BV64

**E**



**Acabados**  
Hierro patinado

↑ 34

←—→ 85

938

**C**



**Acabados**  
Latón envejecido

○—○ 64

←—→ 97

910

**B**



**Acabados**  
Latón envejecido

○—○ 64

←—→ 88

499

**F**



**Acabados**  
Latón pulido

∅ 34 40

909

**B**



**Acabados**  
Latón envejecido

↑ 49

←—→ 34

942

C



**Acabados**  
Latón envejecido

↑ 97  
↔ 33

941

C



**Acabados**  
Latón envejecido

↑ 97  
↔ 33

638

E



**Acabados**  
Latón antiguo

○—○ 64

997

B



**Acabados**  
Latón envejecido

○—○ 52 64  
↔ 70 82

914

B



**Acabados**  
Latón oxidado

↑ 88

P02075

D



**Acabados**  
Óxido verde

↑ 50  
↔ 50

802 - Tarjetero

A



**Acabados**  
Latón natural, Latón envejecido manchas y Níquel brillo

↑ 29  
↔ 80

801

B



**Acabados**  
Cromo, Latón envejecido y Níquel brillo

↔ 80

812 - Embutir

B



**Acabados**  
Latón envejecido

↔ 60 85

804

B



**Acabados**  
Oro patinado

○—○ 32 32  
↔ 74 89

803

B



**Acabados**  
Latón envejecido y Florencia

↑ 31 37  
↔ 77 96

PETRA

B



**Acabados**  
Cobre antiguo, Plata antigua y Negro

○—○ 64  
↔ 97

PETRA

(B)



**Acabados**  
Plata antigua

○—○ 64  
←→ 97

806

(D)



**Acabados**  
Plata vieja

○—○ 32 38  
←→ 79 95

D8421/D8424

(A)



**Acabados**  
Negro decapado

↑ 12 26  
⊘ 20 35

D8472

(B)



**Acabados**  
Negro decapado

↑ 35  
←→ 24

1805

(D)



**Acabados**  
Cromo

○—○ 32  
←→ 97

3060

(D)



**Acabados**  
Cromo, Como mate, Níquel mate, Latón pulido y Cuero

↑ 45 45  
○—○ 70 90

D415L2

(B)



**Acabados**  
Negro decapado

○—○ 55  
←→ 69

D4152

(B)



**Acabados**  
Negro decapado

○—○ 55  
←→ 69

PETRA

(A)



**Acabados**  
Negro

○—○ 64  
←→ 97

16225

(B)



**Acabados**  
Níquel mate y Negro

○—○ 128  
←→ 150

D10152

(C)



**Acabados**  
Negro decapado

○—○ 96  
←→ 123

D8322

(B)



**Acabados**  
Negro decapado

⊘ 50

D8421

(A)



**Acabados**

Blanco, Azul\* y Rosa\* decapado



D8424

(B)



**Acabados**

Blanco, Azul y Rosa\* decapado



D4152

(B)



**Acabados**

Blanco decapado

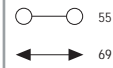

D415L2

(B)



**Acabados**

Azul y Rosa decapado

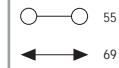

D8472

(B)



**Acabados**

Blanco, Azul\* y Rosa\* decapado

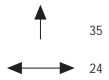

D817F

(C)



**Acabados**

Blanco y Rosa\* decapado



D10132

(B)



**Acabados**

Blanco decapado

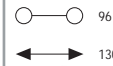

D10152

(C)



**Acabados**

Blanco y Azul decapado

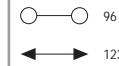

D8322

(B)



**Acabados**

Blanco y Rosa decapado



D9401

(A)



**Acabados**

Blanco decapado

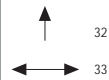

D1011

(B)



**Acabados**

Azul y Rosa\* decapado

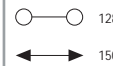

D10101

(B)



**Acabados**

Blanco decapado

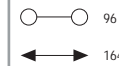

BV5251

(C)



**Acabados**  
Hierro patinado

∅ 25 30 35

BV5208

(B)



**Acabados**  
Hierro patinado

∅ 25 30 35

DUKE

(B)



**Acabados**  
Negro, Plata antigua y Peltre

↑ 26  
∅ 32

DUKE

(A)



**Acabados**  
Cobre antiguo y Latón antiguo

↑ 26  
∅ 32

932

(B)



**Acabados**  
Latón envejecido

∅ 30 37

MG936

(B)



**Acabados**  
Latón antiguo y Latón envejecido

∅ 30 37

RAVIOLLO

(A)



**Acabados**  
Latón antiguo y Peltre

↑ 29  
∅ 27

101

(A)



**Acabados**  
Latón antiguo

↑ 16 20 23  
∅ 20 25 30

948

(B)



**Acabados**  
Latón envejecido y Plata antigua

∅ 25 30 35

1819

(B)



**Acabados**  
Plata antigua

∅ 30

963

(B)



**Acabados**  
Latón patinado

∅ 25 30

968

(B)



**Acabados**  
Latón envejecido

∅ 25 30

## Victoria

(B)



### Acabados

Plata-Acero negro

↑ 31  
⊘ 33

## Victoria

(B)



### Acabados

Plata-Acero negro

○—○ 128  
←→ 145

## RAVILO

(A)



### Acabados

Latón antiguo y Peltre

↑ 29  
⊘ 27

## 550

(A)



### Acabados

Blanco-Arena, Blanco-Cuero blanco, Bronce-Negro, Plata antigua-Arena y Plata antigua-Cuero gris

↑ 26  
⊘ 37

## DUKE

(B)



### Acabados

Cobre antiguo, Latón antiguo, Plata antigua, Peltre y Negro

↑ 26  
⊘ 32

## DUKE

(B)



### Acabados

Cobre antiguo, Latón antiguo, Plata antigua, Peltre y Negro

↑ 26  
⊘ 32

## 550

(A)



### Acabados

Latón Blanco-Arena, Blanco-Cuero blanco, Bronce-Negro, Plata antigua-Arena y Plata antigua-Cuero gris

↑ 26  
⊘ 37

## 550

(A)



### Acabados

Blanco-Arena, Blanco-Cuero blanco, Bronce-Negro, Plata antigua-Arena y Plata antigua-Cuero gris

↑ 26  
⊘ 37

## TUBE

(A)



### Acabados

Bronce rústico y Estaño rústico

↑ 33  
⊘ 19

## MARCOS

(B)



### Acabados

Acero negro y Plata vieja

↑ 28  
←→ 24

## 550

(A)



### Acabados

Blanco-Arena, Blanco-Cuero blanco, Bronce-Negro, Plata antigua-Arena y Plata antigua-Cuero gris

↑ 26  
⊘ 37

## 550

(A)



### Acabados

Blanco-Arena, Blanco-Cuero blanco, Bronce-Negro, Plata antigua-Arena y Plata antigua-Cuero gris

↑ 26  
⊘ 37

8841 / 7372

(A)



**Acabados**  
Cobre rústico



16873

(B)



**Acabados**  
Bronce

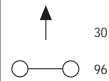

30010

(D)



**Acabados**  
Antracita

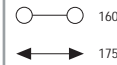

30001

(C)



**Acabados**  
Hierro rústico

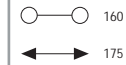

8871

(A)



**Acabados**  
Bronce rústico y Hierro rústico



742

(A)



**Acabados**  
Bronce rústico y Hierro rústico

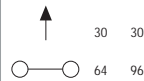

BUTTON

(B)



**Acabados**  
Latón antiguo y Peltre

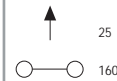

AVA

(A)



**Acabados**  
Latón antiguo y Peltre

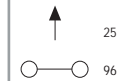

1838

(A)



**Acabados**  
Latón envejecido



1837

(B)



**Acabados**  
Latón envejecido



813

(C)



**Acabados**  
Latón envejecido

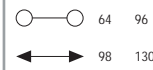

7031

(A)



**Acabados**  
Bronce

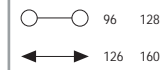



MG131

(E)



**Acabados**

Cromo, Latón pulido, Plata antigua, Envejecido antiguo y Envejecido manchas

○—○ 96 128

←—→ 120 160

193964

(A)



**Acabados**

Acero negro, Plata vieja brillo, Plata vieja mate

○—○ 128

←—→ 169

TUBE

(B)



**Acabados**

Bronce rústico y Estaño rústico

↑ 192

○—○ 212

MN2529

(E)



**Acabados**

Bronce oscuro

↑ 160 320

○—○ 178 338

17882

(C)



**Acabados**

Níquel mate y Plata envejecida

○—○ 160

←—→ 171

113954

(B)



**Acabados**

Acero negro, Plata vieja brillo y Plata vieja mate

○—○ 96

←—→ 140

17811

(C)



**Acabados**

Metal

○—○ 128 160

←—→ 143 175

REDO

(B)



**Acabados**

Cobre mate

○—○ 128 192

←—→ 137 201

193966

(B)



**Acabados**

Acero negro, Plata vieja brillo y Plata vieja mate

○—○ 128

←—→ 137

193968

(B)



**Acabados**

Acero negro, Plata vieja brillo, Plata vieja mate

○—○ 160

←—→ 180

VERSO

(B)



**Acabados**

Latón antiguo y Peltre

○—○ 192

←—→ 224

VERSO

(A)

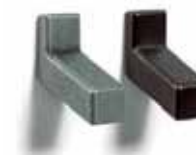

**Acabados**

Latón antiguo y Peltre

↑ 31

←—→ 26

522

C



**Acabados**

Níquel mate, Latón mate y Cobre antiguo\*

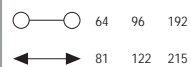

523

C



**Acabados**

Níquel mate, Latón mate y Cobre antiguo\*



400

B



**Acabados**

Cromo, Latón pulido y Latón mate



381

Knud Holscher

F



**Acabados**

Latón pulido, Negro e Inox AISI 316L

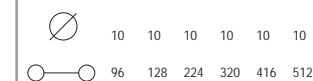

526

E



**Acabados**

Cromo\*, Cromo mate, Latón pulido\* y Latón mate



PF0400

Pininfarina

E



**Acabados**

Latón pulido y Latón mate

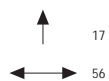

6763

A



**Acabados**

Grafito y Oro mate

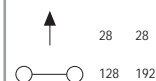

U128

A



**Acabados**

Latón mate y Negro



MG131128

F



**Acabados**

Latón pulido

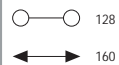

451

D



**Acabados**

Cromo, Níquel mate, Latón pulido y Latón mate

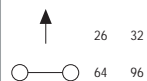

A167

B



**Acabados**

Latón pulido, Negro y Blanco

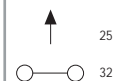

400

B



**Acabados**

Cromo-Cristal negro y Latón pulido-Cristal negro



2373

(B)



Acabados  
Oro



A792

(E)



Acabados  
Latón pulido

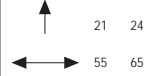

153

(A)



Acabados  
Níquel mate, Latón pulido y Latón mate



156

(B)



Acabados  
Cromo mate, Latón mate, y Níquel mate

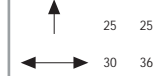

PNMAB

(F)



Acabados  
Latón pulido



43229

(B)



Acabados  
Latón y Plata

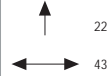

165

(A)



Acabados  
Cromo, Latón mate, Níquel mate y Oro



847

(A)



Acabados  
Cromo, Latón pulido y Bronce viejo



FLX32AB

(F)



Acabados  
Latón pulido

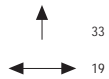

FLR40AB

(F)



Acabados  
Latón pulido

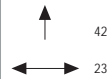

105

(B)



Acabados  
Latón pulido y Latón mate



146

(A)



Acabados  
Latón pulido



596

C



**Acabados**

Cromo, Cromo mate, Níquel mate, Latón pulido, Latón mate, Cobre antiguo\*, Negro y Blanco



GRAFLM

A



**Acabados**

Latón mate, Simil inox, Aluminio anodizado y Negro



3060

C



**Acabados**

Cromo, Cromo mate, Níquel mate, Latón pulido y Cuero

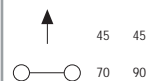

A244C

B



**Acabados**

Níquel mate y Oro

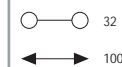

595

B



**Acabados**

Cromo, Cromo mate, Níquel mate, Latón pulido, Latón mate, Negro y Blanco



700D

B



**Acabados**

Latón pulido y Aluminio satiado



MN634

B



**Acabados**

Aluminio - Cuero claro / Oscuro

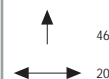

P0339

B



**Acabados**

Aluminio - Cuero claro / Oscuro

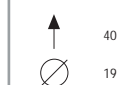

580

C



**Acabados**

Níquel brillo, Níquel pulido y Latón pulido



8161 / 8151

A



**Acabados**

Oro mate y Grafito

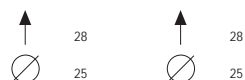

532

B



**Acabados**

Cromo mate - Cuero marrón

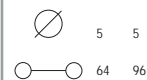

16754

B



**Acabados**

Cromo mate - Cuero



A277A

(C)

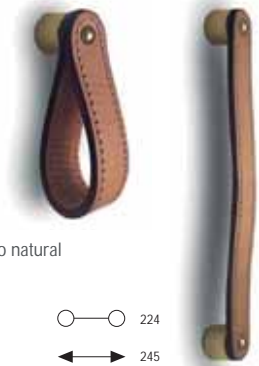

**Acabados**

Latón pulido - Cuero natural



17161

(B)



**Acabados**

Cromo mate - Negro / Cuero marrón



MN2025U / MN2026U

(F)



**Acabados**

Cuero marrón

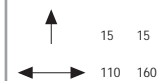

CI224U / CI225U

(F)



**Acabados**

Cuero marrón

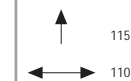

970

(B)



**Acabados**

Cuero camel, Marrón, Marrón oscuro

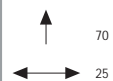

970

(B)



**Acabados**

Cuero negro y Blanco

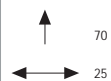

002

(E)



**Acabados**

Cuero Azul\* / Piedra\* / Granate\* / Gris\* / Marfil\* / Blanco\* / Marrón / Marrón oscuro / Negro\*

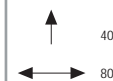

1702016

(D)



**Acabados**

Cuero negro

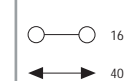

FLEXA

(C)



**Acabados**

Cromo, Latón mate, Peltre y Negro - Cuero negro

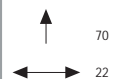

FLEXA128

(C)



**Acabados**

Cromo, Latón mate, Peltre y Negro - Cuero negro

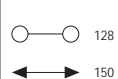

F013

(F)



**Acabados**

Piel grabada marrón

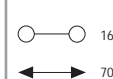

F014

(F)



**Acabados**

Piel potro marrón

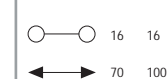

MN604

D



**Acabados**

Aluminio - Cuero oscuro

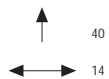

17224

C



**Acabados**

Níquel mate - Cuero claro / Oscuro

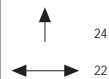

F009

C



**Acabados**

Cuero marrón / Beige

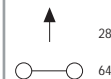

006

E



**Acabados**

Cuero Azul\* / Piedra\* / Granate\* / Gris\* / Marfil\* / Blanco\* / Marrón / Marrón oscuro / Negro\*



009

F



**Acabados**

Cuero Azul\* / Piedra\* / Granate\* / Gris\* / Marfil\* / Blanco\* / Marrón / Marrón oscuro / Negro\*

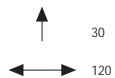

17361

F



**Acabados**

Cuero marrón / Marrón oscuro / Negro

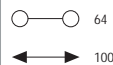

013

E



**Acabados**

Cuero Azul\* / Piedra\* / Granate\* / Gris\* / Marfil\* / Blanco\* / Marrón / Marrón oscuro / Negro\*

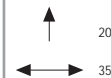

012

F



**Acabados**

Cuero Azul\* / Piedra\* / Granate\* / Gris\* / Marfil\* / Blanco\* / Marrón / Marrón oscuro / Negro\*



531

C



**Acabados**

Cuero marrón



537

B



**Acabados**

Cuero marrón

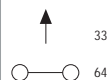

001

E



**Acabados**

Cuero Azul\* / Piedra\* / Granate\* / Gris\* / Marfil\* / Blanco\* / Marrón / Marrón oscuro / Negro\*

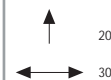

008

E



**Acabados**

Cuero Azul\* / Piedra\* / Granate\* / Gris\* / Marfil\* / Blanco\* / Marrón / Marrón oscuro / Negro\*



003

C



**Acabados**

Cuero Azul\* / Piedra\* / Granate\* / Gris\* / Marfil\* / Blanco\* / Marrón / Marrón oscuro / Negro\*



48007

E



**Acabados**

Aluminio - Cuero Blanco / Marrón / Negro / Rojo

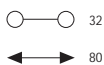

611

E



**Acabados**

Cromo mate - Cuero marrón / Marrón oscuro

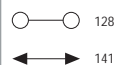

014

F



**Acabados**

Cuero Azul\* / Piedra\* / Granate\* / Gris\* / Marfil\* / Blanco\* / Marrón / Marrón oscuro / Negro\*



615/614

D



**Acabados**

Cromo mate - Cuero marrón / Marrón oscuro



609

D



**Acabados**

Cromo mate - Cuero marrón / Marrón oscuro



48014/48016

E



**Acabados**

Aluminio - Cuero Blanco / Marrón / Negro / Rojo

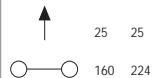

608

D



**Acabados**

Cromo mate - Cuero marrón / Marrón oscuro

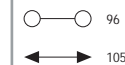

48009

E



**Acabados**

Aluminio - Cuero Blanco / Marrón / Negro / Rojo

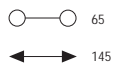

17517

C



**Acabados**

Cromo mate - Aluminio mate, Cromo mate - Cuero marrón claro / Oscuro



F003

F



**Acabados**

Cuero marrón / Beige

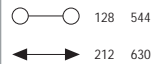

005

F



**Acabados**

Níquel mate - Cuero Azul\* / Piedra\* / Granate\* / Gris\* / Marfil\* / Blanco\* / Marrón / Marrón oscuro / Negro\*

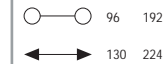

17364

(E)



**Acabados**

Cromo - Madera haya

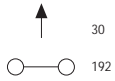

17520

(D)



**Acabados**

Cromo - Madera wengué

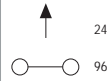

17599

(F)



**Acabados**

Cromo - Cedro y Cromo mate - Cedro

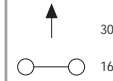

BK40401

(F)



**Acabados**

Madera cebrano - Blanco

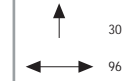

BK30501

(F)



**Acabados**

Madera olivo - Blanco

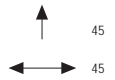

BK10401

(F)



**Acabados**

Madera cebrano - Blanco

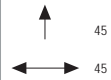

16224

(A)



**Acabados**

Negro mate - Madera



BALTO

(C)



**Acabados**

Madera Negro, Blanco, Marrón y Crudo

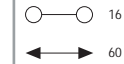

BK20401

(F)



**Acabados**

Madera cebrano - Blanco

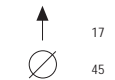

1781

(A)



**Acabados**

Madera blanco y Madera wengué

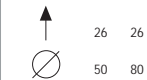

ECHO

(B)



**Acabados**

Madera Negro, Blanco, Marrón y Crudo



ECHO

(B)



**Acabados**

Madera Negro, Blanco, Marrón y Crudo





1734

(A)



**Acabados**

Madera barniz transparente

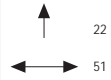

1732

(A)



**Acabados**

Madera barniz transparente

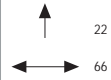

1785

(B)



**Acabado:**

Madera Blanco, Madera naranja, Madera pistacho y Madera wengué

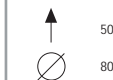

372

(B)



**Acabados**

Goma Beige



1735

(A)



**Acabados**

Madera barniz transparente

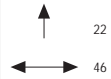

1733

(A)



**Acabados**

Madera barniz transparente

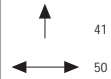

110A1

(B)



**Acabados**

Bambú trenzado

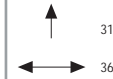

1780

(B)



**Acabados**

Madera blanco y Madera wengué

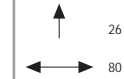

1738

(A)



**Acabados**

Madera natural, Nogal y Barniz transparente

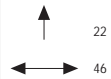

1737

(A)



**Acabados**

Madera natural, Nogal y Barniz transparente

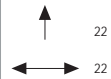

1736

(A)



**Acabados**

Madera natural, Nogal y Barniz transparente

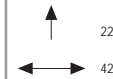

453

(B)



**Acabados**

Madera decapada gris



## ARATI

(A)



**Acabados**  
Porcelana gris

↑ 38  
⊘ 38

## BINDI

(A)



**Acabados**  
Porcelana negro y crema

↑ 38  
⊘ 38

## GOPI

(B)



**Acabados**  
Porcelana blanco y dorado

↑ 38  
⊘ 44

## GHAT

(A)



**Acabados**  
Porcelana crema y negro

↑ 38  
⊘ 44

## DEVA

(A)



**Acabados**  
Porcelana blanco y negro

↑ 38  
⊘ 44

## VEDA

(A)



**Acabados**  
Porcelana blanco y azul

↑ 38  
⊘ 38

## MANDIR

(B)



**Acabados**  
Porcelana dorada

↑ 38  
⊘ 38

## MANDIR

(B)



**Acabados**  
Porcelana plateada

↑ 38  
⊘ 38

## DIYA

(A)



**Acabados**  
Porcelana blanco roto

↑ 38  
⊘ 44

## DURGA

(B)



**Acabados**  
Porcelana crema y negro

↑ 38  
⊘ 44

## MELA

(B)



**Acabados**  
Porcelana crema y dorado

↑ 38  
⊘ 38

## PRANA

(A)



**Acabados**  
Porcelana blanco y azul

↑ 32  
⊘ 38

## TULSI

(B)



### Acabados

Porcelana blanco y azul

↑ 25  
⊘ 38

## ARUNA

(A)



### Acabados

Porcelana blanco y rosa

↑ 38  
⊘ 38

## 375

(A)



### Acabados

Porcelana marfil

↑ 25  
⊘ 37

## 745

(C)



### Acabados

Porcelana

⊘ 30 31 37

## ANANDA

(A)



### Acabados

Porcelana rosa y blanco

↑ 38  
⊘ 38

## ANALA

(A)



### Acabados

Porcelana rosa y blanco

↑ 38  
⊘ 38

## 374

(A)



### Acabados

Porcelana marfil

↑ 25  
⊘ 33

## 17172

(D)



### Acabados

Cromo mate - Cristal Swarovski transparente

↑ 20  
↔ 30

## DIDI



### Acabados

Porcelana crema

↑ 38  
⊘ 38

## MUDRA



### Acabados

Porcelana crema y blanco

↑ 32  
⊘ 28

## 1486

(B)



### Acabados

Níquel mate

↑ 16  
↔ 36,6

## 390BR

(B)



### Acabados

Bronce-Porcelana crema

○—○ 96  
↔ 112



**Acabados**  
Porcelana

↑ 50  
↔ 60



**Acabados**  
Porcelana

↑ 50  
↔ 70



**Acabados**  
Porcelana

↑ 60  
↔ 60



**Acabados**  
ABS serigrafiado

↑ 85  
↔ 50



**Acabados**  
Porcelana

↑ 60  
↔ 60



**Acabados**  
Porcelana

↑ 80  
↔ 65



**Acabados**  
Porcelana



**Acabados**  
ABS serigrafiado

↑ 85  
↔ 50



**Acabados**  
Porcelana

↑ 75  
↔ 60



**Acabados**  
Porcelana

↑ 75  
↔ 60



**Acabados**  
Porcelana

↑ 40  
↔ 40



**Acabados**  
ABS serigrafiado

↑ 85  
↔ 50

17008

(B)



**Acabados**  
Cromo mate

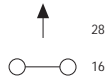

17011

(B)



**Acabados**  
Cromo mate

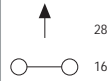

16970

(A)



**Acabados**  
Amarillo transparente

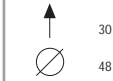

16911/16912

(A)



**Acabados**  
Cromo mate, Níquel mate, Azul claro, Azul oscuro, Amarillo y Verde

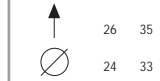

16854

(A)



**Acabados**  
Blanco transparente y Azul transparente

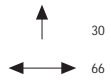

16852

(A)



**Acabados**  
Blanco transparente y Naranja transparente

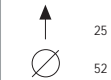

17108

(A)



**Acabados**  
Amarillo



16913

(B)



**Acabados**  
Azul oscuro y Amarillo

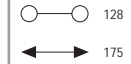

16858

(A)



**Acabados**  
Blanco transparente y Naranja transparente



16856

(A)



**Acabados**  
Blanco transparente y Naranja transparente

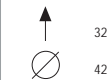

DESCARGAR  
CATÁLOGO



manil lones  
tiradores de puerta

### K377

Steve Leung

(E)

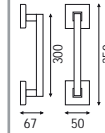

**Acabados**

Titanio, Bronce oscuro, Níquel negro y Negro opaco



### OL199

Piero Lissoni

(D)

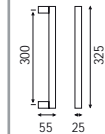

**Acabados**

Cromo, Cromo satinado, Níquel brillo, Inox satinado,  
Cobre satinado, Bronce satinado, Antracita satinado



### Siena

(B)

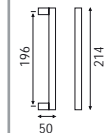

**Acabados**

Negro, Cobre satinado, Bronce oscuro satinado



## OL195 / OL203R

(B)

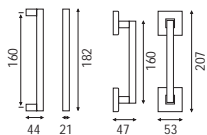

### Acabados

Cromo, Cromo mate, Latón pulido, Níquel brillo, Níquel mate, Inox mate, Cobre satinado, Bronce satinado y Antracita



## OL204R / OL204

Franco Sargiani

(F)

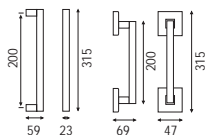

### Acabados

Cromo, Cromo mate, Níquel brillo, Inox mate, Cobre satinado y Bronce satinado



## G827M

(A)

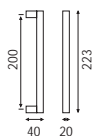

### Acabados

Grafito y Negro



## OL206R / OL206

(E)

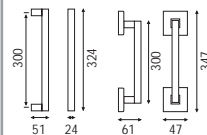

### Acabados

Cromo, Cromo satinado, Níquel brillo, Inox satinado, Cobre satinado, Bronce satinado y Antracita satinado



## ARCO

Marcello Cutino

(E)

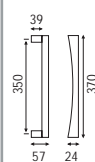

### Acabados

Cromo mate, Latón antiguo y Antracita



## OL200

Piero Lissoni

(D)

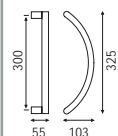

### Acabados

Cromo, Cromo satinado, Níquel brillo, Inox satinado, Cobre satinado, Bronce satinado y Antracita satinado



# MANILLONES Y TIRADORES DE PUERTA



**C015NG**

(C)

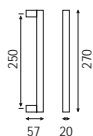

**Acabados**

Inox AISI 316L lacado blanco o negro



**IT153NG**

(D)

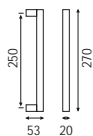

**Acabados**

Inox AISI 316L lacado blanco o negro



**260FNEG**

(E)

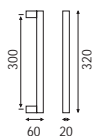

**Acabados**

Inox AISI 316L lacado blanco o negro



**200Q711NG**

(C)



**Acabados**

Cromo mate y Negro



**FENICE**

(B)

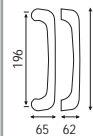

**Acabados**

Antracita



**IBIS**

(B)

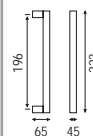

**Acabados**

Cromo mate, Laton pulido y Antracita





# MANILLONES Y TIRADORES DE PUERTA



## TOP Q SERIE ALU

(D)

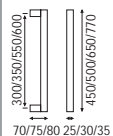

**Acabados**  
Aluminio anodizado Bronce, Negro y Plata  
\*\*Servicio LOG



## TOP SERIE ALU

(D)

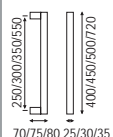

**Acabados**  
Aluminio anodizado Bronce, Negro y Plata  
\*\*Servicio LOG



## TOP INCLINADO SERIE ALU

(D)

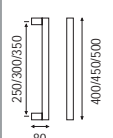

**Acabados**  
Aluminio anodizado Bronce, Negro y Plata  
\*\*Servicio LOG



## C015BL

(C)



**Acabados**  
Inox AISI 316L lacado blanco o negro



## IT153BL

(D)

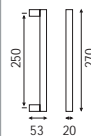

**Acabados**  
Inox AISI 316L lacado blanco o negro



## 260FBL

(E)

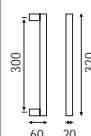

**Acabados**  
Inox AISI 316L lacado blanco o negro



# MANILLONES Y TIRADORES DE PUERTA



## K377 Steve Leung

(F)

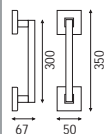

### Acabados

Titanio, Bronce oscuro, Níquel negro y Negro opaco



## TOP Q SERIE ALU

(D)

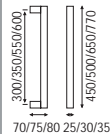

### Acabados

Aluminio anodizado Bronce, Negro y Plata

\*\*Servicio LOG



## TOP SERIE ALU

(D)

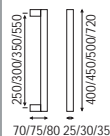

### Acabados

Aluminio anodizado Bronce, Negro y Plata

\*\*Servicio LOG



## 402402300 Knud Holscher

(C)



### Acabados

Inox AISI 316L mate o brillo y d line colors\*



## 461202307 Knud Holscher

(D)



### Acabados

Inox AISI 316L mate o brillo y d line colors\*



## 465202301 Knud Holscher

(F)



### Acabados

Inox AISI 316L mate o brillo y d line colors\*



# MANILLONES Y TIRADORES DE PUERTA

**K368**

Antonio Citterio - Toan Nguyen

(F)

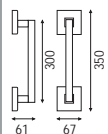

**Acabados**

Cromo y Cromo mate



**K356**

John Pawson

(F)

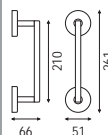

**Acabados**

Cromo y Cromo mate



**K461**

(A)

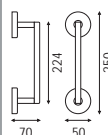

**Acabados**

Cromo



**K352**

Richard Meier

(F)

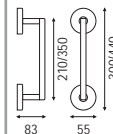

**Acabados**

Cromo



**P5405**

Ricardo Bofill

(F)



**Acabados**

Inox brillo e Inox mate



**P5408**

Antonio Citterio

(F)



**Acabados**

Inox brillo e Inox mate



**P5406**  
Antonio Citterio

(F)

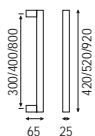

**Acabados**  
Inox brillo e Inox mate



**K354**  
Cerri & Associati

(F)

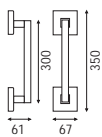

**Acabados**  
Niquel mate - Inox mate



**K358**  
Cerri & Associati

(F)

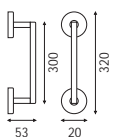

**Acabados**  
Cromo y Cromo mate



**K1226**  
Jean Baptiste Sibertin Blanc

(D)



**Acabados**  
Cromo-cromo mate y Latón pulido



**K359**  
Odile Decq-Benoît Cornette

(F)

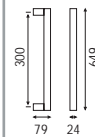

**Acabados**  
Cromo y Cromo mate



**K1228**  
Yoshimi Kono

(E)

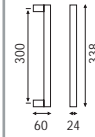

**Acabados**  
Cromo, Cromo mate y Niquel negro



# MANILLONES Y TIRADORES DE PUERTA



**OIT150**  
Programa IT

C

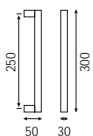

**Acabados**

Inox AISI 316L mate o brillo + Colores RAL



**IT153**  
Programa IT

C



**Acabados**

Inox AISI 316L mate o brillo + Colores RAL



**OIT152**  
Programa IT

C

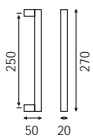

**Acabados**

Inox AISI 316L mate o brillo + Colores RAL



**C015**  
Programa 200

C



**Acabados**

Inox AISI 316L mate o brillo, Blanco y Negro



**OIT151**  
Programa IT

C

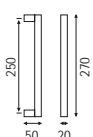

**Acabados**

Inox AISI 316L mate o brillo + Colores RAL



**M16**

D

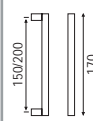

**Acabados**

Cromo, Cromo mate, Latón pulido, Latón mate, Níquel mate y Latón antiguo



# MANILLONES Y TIRADORES DE PUERTA



K1219

(A)

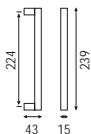

**Acabados**

Inox mate



K1224

(A)

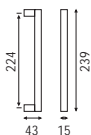

**Acabados**

Inox mate



733

(D)

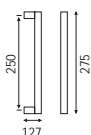

**Acabados**

Cromo mate, Níquel mate, Latón pulido, Latón antiguo



732

(D)



**Acabados**

Cromo, Cromo mate, Níquel mate, Latón antiguo y Latón pulido



Milan

(D)



**Acabados**

Cromo, Cromo mate y Latón mate



Semicurvo

(F)



**Acabados**

Cromo y PVD Latón



# MANILLONES Y TIRADORES DE PUERTA



## Dritto

(F)

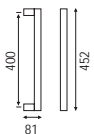

### Acabados

Cromo, PVD Latón



## Megres

(B)



### Acabados

Inox mate - Inox brillo



## Cubo

Cubo Architects

(C)

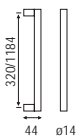

### Acabados

Inox AISI 316 L mate o brillo



## ZAR

(A)

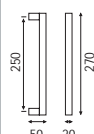

### Acabados

Cromo, Cromo mate, Latón pulido, Latón mate y Níquel mate



## K1210

(C)

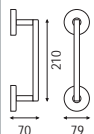

### Acabados

Cromo mate, Latón pulido, Latón mate y Latón antiguo



## K1188

(C)

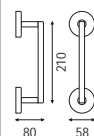

### Acabados

Cromo mate, Latón pulido, Latón mate y Brunito



## RECTO

Serie 200-Tubular

[A]

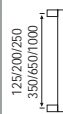

60/65/70/85  
 ø 16/20/25/30/35/40

### Acabados

Inox AISI 316L mate o brillo y PVD oro + Colores RAL



Nylon\*



## Ángulo

Serie 200-Tubular

[C]



70/85/85  
 ø 20/25/30/35

### Acabados

Inox AISI 316L mate o brillo y PVD oro + Colores RAL



Nylon\*



## Acodado

Serie 200-Tubular

[C]

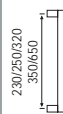

60/70/85  
 ø 20/25/30/35

### Acabados

Inox AISI 316L mate o brillo y PVD oro + Colores RAL



Nylon\*



## Top-curvo

Serie 200-Tubular

[D]

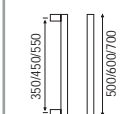

72/77 65/70/90  
 ø 25/30

### Acabados

Inox AISI 316L mate o brillo y PVD oro + Colores RAL



Nylon\*



## Semi-circular

Serie 200-Tubular

[C]

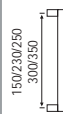

60/70/85  
 ø 20/25/30/35

### Acabados

Inox AISI 316L mate o brillo y PVD oro + Colores RAL



Nylon\*



## Triangular

Serie 200-Tubular

[D]



70/85/85  
 ø 20/30/35

### Acabados

Inox AISI 316L mate o brillo + Colores RAL





# MANILLONES Y TIRADORES DE PUERTA



## En L

Serie 200-Tubular

(D)

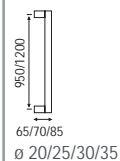

Acabados

Inox AISI 316L mate o brillo + Colores RAL



Nylon\*



## Arco

Serie 200-Tubular

(D)

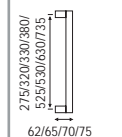

Acabados

Inox AISI 316L mate o brillo + Colores RAL



## Curvo

Serie 200-Tubular

(D)

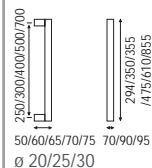

Acabados

Inox AISI 316L mate o brillo y PVD oro + Colores RAL



## Recto F

Serie 200-Tubular

(B)

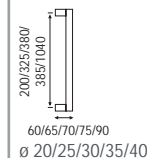

Acabados

Inox AISI 316L mate o brillo y PVD oro + Colores RAL



## 200.101

Serie 200-Tubular

(B)



Acabados

Inox AISI 316L mate o brillo + Colores RAL



## Semi-circular

Serie 200-Tubular

(D)

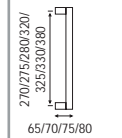

Acabados

Inox AISI 316L mate o brillo + Colores RAL



Nylon\*



## Top inclinado

Serie 200-Tubular

(C)

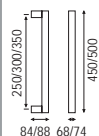

Ø 25/30

### Acabados

Inox AISI 316L mate o brillo + Colores RAL



## Top acodado

Serie 200-Tubular

(E)

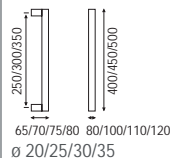

Ø 20/25/30/35

### Acabados

Inox AISI 316L mate o brillo + Colores RAL



## Top

Serie 200-Tubular

(C)

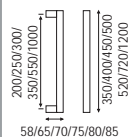

Ø 16/20/25/30/35/40

### Acabados

Inox AISI 316L mate o brillo + Colores RAL



Nylon\*



## Recto I

Serie 200-Tubular

(D)



Ø 25/30

### Acabados

Inox AISI 316L mate o brillo + Colores RAL



## C061

Serie 200

(E)

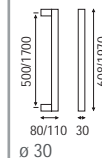

Ø 30

### Acabados

Inox AISI 316L mate o brillo + Colores RAL



## Ángulo

Serie 200E

(E)



Ø 25/30

### Acabados

Inox AISI 316L mate o brillo + Colores RAL



## Top Serie 200E

(E)

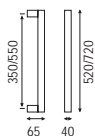

### Acabados

Inox AISI 316L mate o brillo + Colores RAL



## Plano Serie 200E

(E)



### Acabados

Inox AISI 316L mate o brillo + Colores RAL



## Recto Serie 200E

(E)

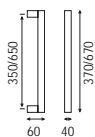

### Acabados

Inox AISI 316L mate o brillo + Colores RAL



## Recto Serie 200Q

(B)

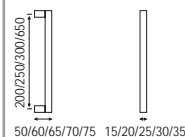

### Acabados

Inox AISI 316L mate o brillo + Colores RAL



## Acodado Serie 200E

(F)

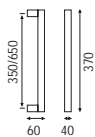

### Acabados

Inox AISI 316L mate o brillo + Colores RAL



## Top Serie 200Q

(D)

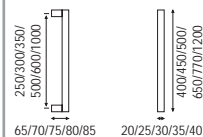

### Acabados

Inox AISI 316L mate o brillo + Colores RAL



# MANILLONES Y TIRADORES DE PUERTA



## Acodado Serie 200Q

(D)

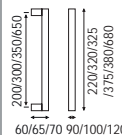

60/65/70 90/100/120

20/25/30

### Acabados

Inox AISI 316L mate o brillo + Colores RAL



## 200Q.061 Serie 200Q

(E)



### Acabados

Inox AISI 316L mate o brillo + Colores RAL



## CQ300 Serie 200Q

(D)

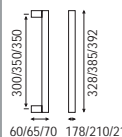

178/210/217

### Acabados

Inox AISI 316L mate o brillo + Colores RAL

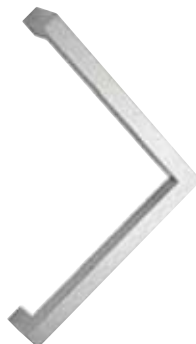

## 200Q.051 Serie 200Q

(E)



### Acabados

Inox AISI 316L mate o brillo + Colores RAL



## 200Q.401 Serie 200Q

(E)

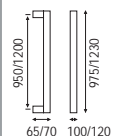

### Acabados

Inox AISI 316L mate o brillo + Colores RAL



## 200Q.111i Serie 200Q

(E)

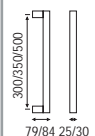

### Acabados

Inox AISI 316L mate o brillo + Colores RAL



**200Q.621**  
Serie 200Q

(D)

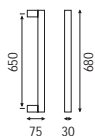

**Acabados**

Inox AISI 316L mate o brillo + Colores RAL



**200Q.621i**  
Serie 200Q

(F)

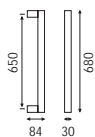

**Acabados**

Inox AISI 316L mate o brillo + Colores RAL



**Eje Inclinado**  
Serie 200IT

(F)



**Acabados**

Inox AISI 316L mate o brillo + Colores RAL



**Recto IT (011)**  
Serie 200IT

(F)



**Acabados**

Inox AISI 316L mate o brillo + Colores RAL



**Recto IT soporte circular (021)**  
Serie 200IT

(E)



**Acabados**

Inox AISI 316L mate o brillo + Colores RAL



**Inclinado IT soporte circular (031)**  
Serie 200IT

(F)



**Acabados**

Inox AISI 316L mate o brillo + Colores RAL



## Recto IT pletina inclinada (041)

Serie 200IT

(E)

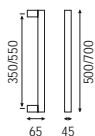

### Acabados

Inox AISI 316L mate o brillo + Colores RAL



## Recto IT soporte circular (051)

Serie 200IT

(E)

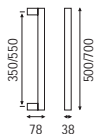

Diámetro 25

### Acabados

Inox AISI 316L mate o brillo + Colores RAL



## Recto IT soporte circular (061)

Serie 200IT

(E)

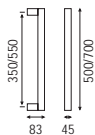

Diámetro 30

### Acabados

Inox AISI 316L mate o brillo + Colores RAL



## Inclinado IT (071)

Serie 200IT

(E)



### Acabados

Inox AISI 316L mate o brillo + Colores RAL



## Semi-circular IT (081)

Serie 200IT

(F)



### Acabados

Inox AISI 316L mate o brillo + Colores RAL



## Semi-circular IT (082)

Serie 200IT

(F)

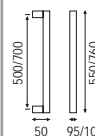

### Acabados

Inox AISI 316L mate o brillo + Colores RAL



## Inclinado IT (091)

Serie 200IT

(F)

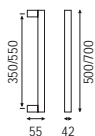

### Acabados

Inox AISI 316L mate o brillo + Colores RAL



## Recto con pletina inclinada (101)

Serie 200IT

(E)

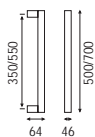

### Acabados

Inox AISI 316L mate o brillo + Colores RAL



## 200P.001

Serie 200P

(D)

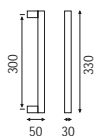

### Acabados

Inox AISI 316L mate o brillo + Colores RAL



## 200P.011

Serie 200P

(E)



### Acabados

Inox AISI 316L mate o brillo + Colores RAL



## 200P.021

Serie 200P

(E)



### Acabados

Inox AISI 316L mate o brillo + Colores RAL



## 200P.031

Serie 200P

(E)



### Acabados

Inox AISI 316L mate o brillo + Colores RAL



# MANILLONES Y TIRADORES DE PUERTA



## 200P.041 Serie 200P

(E)

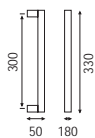

### Acabados

Inox AISI 316L mate o brillo + Colores RAL



## 200P.051 Serie 200P

(F)

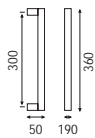

### Acabados

Inox AISI 316L mate o brillo + Colores RAL



## 200P.061 (DER/IZ) Serie 200P

(F)

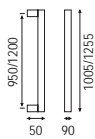

### Acabados

Inox AISI 316L mate o brillo + Colores RAL



## 200C Serie K-Lock

(F)

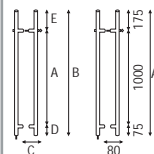

ø 35

### Acabados

Inox AISI 316L mate o brillo + Colores RAL  
Gama completa consultar. Medidas bajo pedido.



## 200C-Y Serie K-Lock

(F)

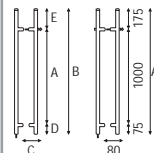

ø 35

### Acabados

Inox AISI 316L mate o brillo + Colores RAL  
Gama completa consultar. Medidas bajo pedido.



## 200C-YE Serie K-Lock Elíptico

(F)

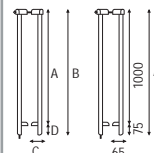

ø 35

### Acabados

Inox AISI 316L mate o brillo + Colores RAL  
Gama completa consultar. Medidas bajo pedido.





## 200C-V Serie K-Lock

(F)

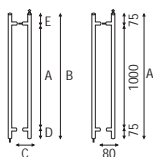

∅ 35

### Acabados

Inox AISI 316L mate o brillo + Colores RAL  
Gama completa consultar. Medidas bajo pedido.



## KLO.QY Serie K-Lock Cuadrado

(F)

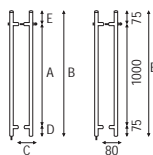

### Acabados

Inox AISI 316L mate o brillo + Colores RAL  
Gama completa consultar. Medidas bajo pedido.



## KLO.QV1/2/3 Serie K-Lock Cuadrado

(F)

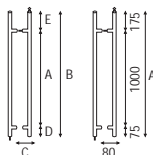

### Acabados

Inox AISI 316L mate o brillo + Colores RAL  
Gama completa consultar. Medidas bajo pedido.



## KLA Serie K-Lock

(F)

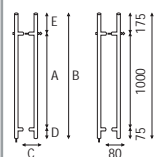

∅ 37

### Acabados

Aluminio anodizado Plata, Bronce y Negro  
Gama completa consultar. Medidas bajo pedido.



## KLR Serie K-Lock

(F)

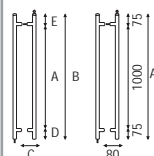

∅ 25

### Acabados

Inox AISI 316L mate o brillo + Colores RAL  
Gama completa consultar. Medidas bajo pedido.



## KLD Serie K-Lock con cilindro electrónico

(F)

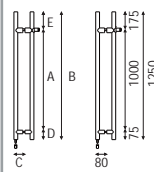

∅ 35

### Acabados

Inox AISI 316L mate o brillo + Colores RAL  
Gama completa consultar. Medidas bajo pedido.



## KLL Serie K-Lock cuero

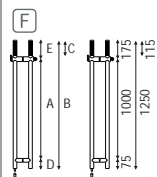

Perímetro 50x20  
**Acabados**  
 Inox AISI 316L mate o brillo-cuero negro/marrón/beige/rojo + Colores RAL  
 Gama completa consultar. Medidas bajo pedido.

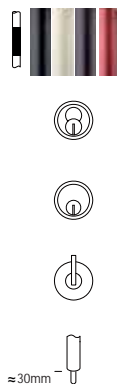

## KLP Serie K-Lock Cuadrado

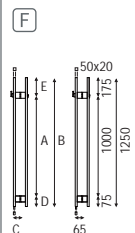

**Acabados**  
 Inox AISI 316L mate o brillo + Colores RAL  
 Gama completa consultar. Medidas bajo pedido.

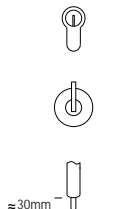

## YOD.201 Serie Yod

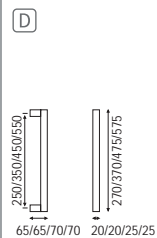

**Acabados**  
 Inox AISI 316L mate o brillo-madera fresno/caoba/wengué



## YOD.211 Serie Yod

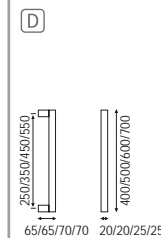

**Acabados**  
 Inox AISI 316L mate o brillo-madera fresno/caoba/wengué



## YOD.301 Serie Yod

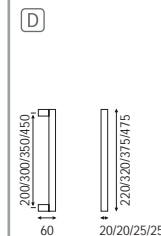

**Acabados**  
 Inox AISI 316L mate o brillo-madera fresno/caoba/wengué



## YOD.311 Serie Yod

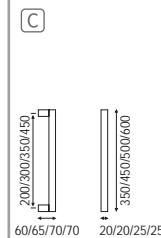

**Acabados**  
 Inox AISI 316L mate o brillo-madera fresno/caoba/wengué



# MANILLONES Y TIRADORES DE PUERTA



## YOD.401 Serie Yod

D

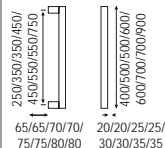

**Acabados**  
Inox AISI 316L mate o brillo-madera  
fresno/caoba/wengué



## YOD.411 Serie Yod

E

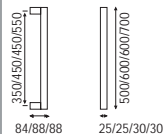

**Acabados**  
Inox AISI 316L mate o brillo-madera  
fresno/caoba/wengué



## 260FNGWE

D

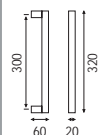

**Acabados**  
Inox AISI 316L negro-madera wengué



## 260FBLRO

D



**Acabados**  
Inox AISI 316L blanco-madera roble



## LUCA

F

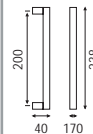

**Acabados**  
Madera Cebrano, Olivo, Roble y Wengué



## YOD.001 Serie Yod

F

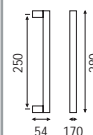

**Acabados**  
Inox AISI 316L mate o brillo-madera  
fresno/caoba/wengué



# MANILLONES Y TIRADORES DE PUERTA



**YOD.011**  
Serie Yod

(F)

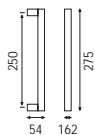

**Acabados**

Inox AISI 316L mate o brillo-madera  
fresno/caoba/wengué



**YOD.021**  
Serie Yod

(F)

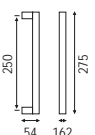

**Acabados**

Inox AISI 316L mate o brillo-madera  
fresno/caoba/wengué



**YOD.041**  
Serie Yod

(F)

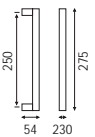

**Acabados**

Inox AISI 316L mate o brillo-madera  
fresno/caoba/wengué



**YOD.031**  
Serie Yod

(F)

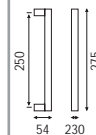

**Acabados**

Inox AISI 316L mate o brillo-madera  
fresno/caoba/wengué



**YOD.501 recto cuero**  
Serie Yod

(F)

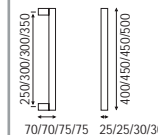

**Acabados**

Inox AISI 316L mate o brillo-cuero  
negro/marrón/beige/rojo



**YOD.501 Inclinado cuero**  
Serie Yod

(F)

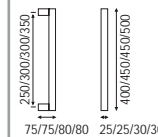

**Acabados**

Inox AISI 316L mate o brillo-cuero  
negro/marrón/beige/rojo



## 260FCUNG

(F)

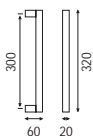

### Acabados

Inox AISI 316L negro-cuero negro



## 260FCUBL

(F)

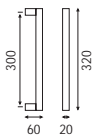

### Acabados

Inox AISI 316L blanco-cuero blanco



## 030

(C)

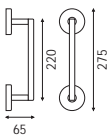

### Acabados

Cuero marrón/marrón oscuro/blanco/piedra/negro/marfil/granate/gris/azul



## 031

(C)

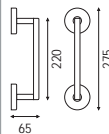

### Acabados

Aluminio F6-cuero marrón/marrón oscuro/blanco/piedra/negro/marfil/granate/gris/azul



## ARCON CUERO

Servicio de forrado de herrajes con cuero. Elija el manillón que más le guste y el cuero del color que prefiera.

### Acabados

En la foto: Inox mate con cuero color azul

Colores de cuero disponibles: Cuero marrón/marrón oscuro/blanco/piedra/negro/marfil/granate/gris/azul



## ARCON CUERO

Servicio de forrado de herrajes con cuero. Elija el manillón que más le guste y el cuero del color que prefiera.

### Acabados

En la foto: Inox mate con cuero color piedra

Colores de cuero disponibles: Cuero marrón/marrón oscuro/blanco/piedra/negro/marfil/granate/gris/azul



## STA2010030

STEELALU

(F)

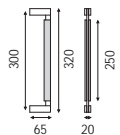

### Acabados

Acero inoxidable AISI 316L – Aluminio champagne, bronce o negro



## STA3010030

STEELALU

(D)

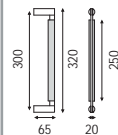

### Acabados

Acero inoxidable AISI 316L – Aluminio champagne, bronce o negro



## STA2110030

STEELALU

(F)

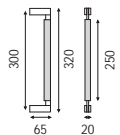

### Acabados

Acero inoxidable AISI 316L – Aluminio champagne, bronce o negro

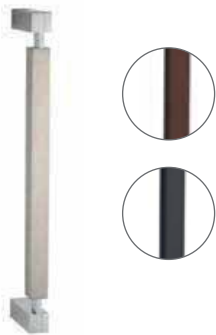

## STA4110030

STEELALU

(D)

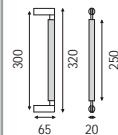

### Acabados

Acero inoxidable AISI 316L – Aluminio champagne, bronce o negro

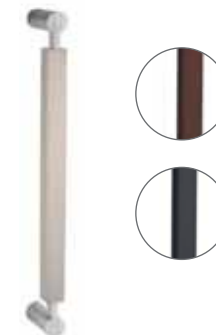

## STA2210030

STEELALU

(F)

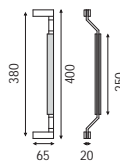

### Acabados

Acero inoxidable AISI 316L – Aluminio champagne, bronce o negro



## STA4210030

STEELALU

(E)

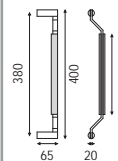

### Acabados

Acero inoxidable AISI 316L – Aluminio champagne, bronce o negro



# MANILLONES Y TIRADORES DE PUERTA

TA16MFRA

(C)

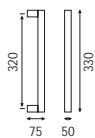

Acabados

Fragua



TA16MOX

(C)



Acabados

Óxido



TA12FRA

(B)

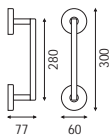

Acabados

Fragua



TA12OX

(B)

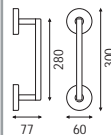

Acabados

Óxido



TA14

(E)

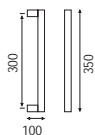

Acabados

Fragua y Óxido



FORJAMN  
Ernest Altés

(D)

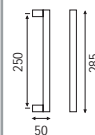

Acabados

Hierro forjado



## 20105FRA

C

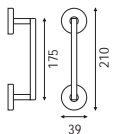

**Acabados**  
Fragua



## 20105OX

B

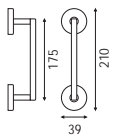

**Acabados**  
Óxido



## G809M

A

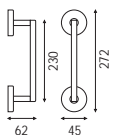

**Acabados**  
Latón marrón



## SIENA

C

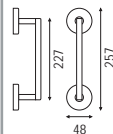

**Acabados**  
Cromo mate-ébano, Latón pulido-ébano y Níquel brillo-ébano



## JEANNE

Colección Enrico Cassina

E

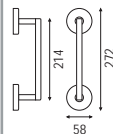

**Acabados**  
Cromo, Cromo mate, Latón pulido, Níquel, Níquel mate, Bronce antiguo y Negro



## DORA

Colección Enrico Cassina

D

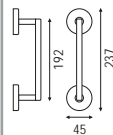

**Acabados**  
Cromo, Cromo mate, Latón pulido, Níquel, Níquel mate, Bronce antiguo y Negro





## OL195 / OL203R

(B)

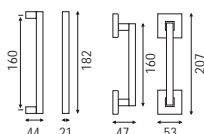

### Acabados

Cromo, Cromo mate, Latón pulido, Níquel brillo, Níquel mate, Inox mate, Cobre satinado, Bronce satinado y Antracita



## Manos

### Oscar Tusquets Blanca

(C)

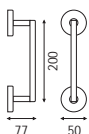

### Acabados

Latón mate



## Sidone

### Maurizio Duranti

(B)

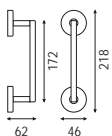

### Acabados

Latón pulido



## P5405/K353

### Ricardo Bofill

(F)



### Acabados

Inox, Inox mate, Níquel mate, Cromo-cromo mate y Latón pulido-latón mate



## ZAR

(D)

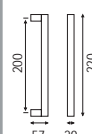

### Acabados

Cromo, Cromo mate, Latón pulido, Latón mate y Níquel mate



## M16

(D)

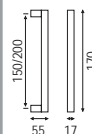

### Acabados

Cromo, Cromo mate, Latón pulido, Latón mate, Latón antiguo y Níquel mate



## SIENA

(B)

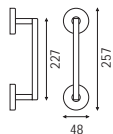

### Acabados

Cromo mate-ébano, Latón pulido-ébano y Níquel brillo-ébano



## LILLY

Colección Enrico Cassina

(D)

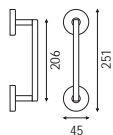

### Acabados

Cromo, Cromo mate, Latón pulido, Níquel, Níquel mate, Bronce antiguo y Negro



## MELANIE

Colección Enrico Cassina

(D)

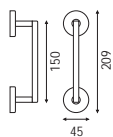

### Acabados

Cromo, Cromo mate, Latón pulido, Níquel, Níquel mate, Bronce antiguo y Negro



## MENEN

Colección Enrico Cassina

(C)

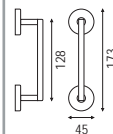

### Acabados

Latón pulido y Bronce antiguo



## 705

Colección Enrico Cassina

(C)

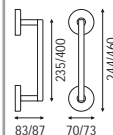

### Acabados

Latón pulido y Bronce antiguo



## 1334

Serie Katy

(B)

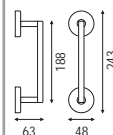

### Acabados

Latón pulido, Latón mate y Latón antiguo



## ZANTE

C

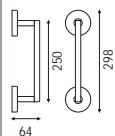

### Acabados

Cromo mate y Latón pulido



## K1210

C

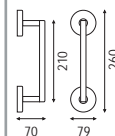

### Acabados

Cromo mate, Latón pulido, Latón mate y Latón antiguo



## ONDA

B

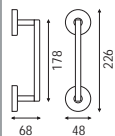

### Acabados

Latón pulido y Latón mate



## 711

C

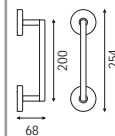

### Acabados

Latón pulido



## K1188

C

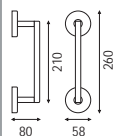

### Acabados

Cromo mate, Latón pulido, Latón mate y Brunito



## 713

Colección Enrico Cassina

D

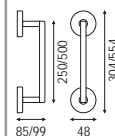

### Acabados

Latón pulido y Níquel mate



# MANILLONES Y TIRADORES DE PUERTA

## EUGENIE

Colección Enrico Cassina

C

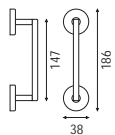

### Acabados

Latón pulido y Bronce antiguo



## C44900

Colección Enrico Cassina

E

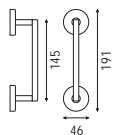

### Acabados

Latón pulido y Bronce antiguo



## C49200

Colección Enrico Cassina

F

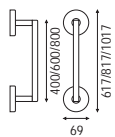

### Acabados

Latón pulido y Bronce antiguo



## IMPERO

D

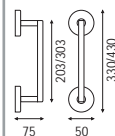

### Acabados

Latón pulido



## MODERNISTA

F

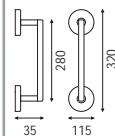

### Acabados

Latón pulido



## GAUDÍ

E

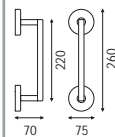

### Acabados

Latón pulido



# MANILLONES Y TIRADORES DE PUERTA

**4250BR**

Embutir

**D**



**Acabados**  
Bronce Claro



**4251BR**

Embutir

**D**

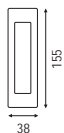

**Acabados**  
Bronce Claro



**CEN3M**

Embutir

**A**

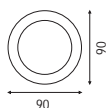

**Acabados**  
Fragua y Óxido



**CEN1M**

Embutir

**A**



**Acabados**  
Fragua y Óxido



**CEN2M**

Embutir

**A**



**Acabados**  
Fragua y Óxido



**CEN4M**

Embutir

**A**

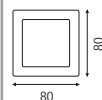

**Acabados**  
Fragua y Óxido



# MANILLONES Y TIRADORES DE PUERTA



**595**  
Embutir

(A)

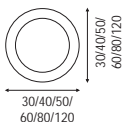

**Acabados**

Cromo, Cromo mate, Latón pulido, Latón mate, Níquel mate, Negro y Blanco



**596**  
Embutir

(A)

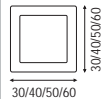

**Acabados**

Cromo, Cromo mate, Latón pulido, Latón mate, Níquel mate, Negro y Blanco



**I4502**  
Embutir con muelle

(A)

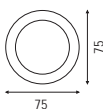

**Acabados**

Inox mate



**I4501**  
Embutir con muelle

(A)

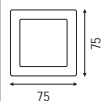

**Acabados**

Inox mate

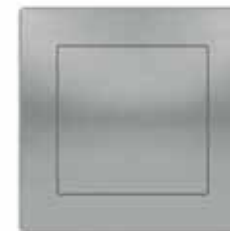

**I4504**  
Embutir con muelle

(A)



**Acabados**

Inox mate



**I4503**  
Embutir con muelle

(A)

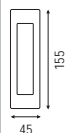

**Acabados**

Inox mate



# MANILLONES Y TIRADORES DE PUERTA



**593**  
Kit corredera paso magnético

**B**



**Acabados**  
Cromo, Cromo mate y Latón pulido



**1696/2639/2651**  
Embutir

**A**

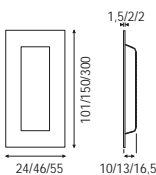

**Acabados**  
Inox mate y Negro



**XBEUNO/ XBEDUE**  
Embutir

**B**

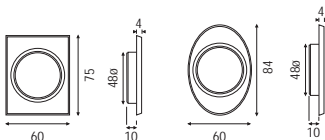

**Acabados**  
Cromo mate, Latón pulido y Níquel mate



**390002077/ 390002051**  
Knud Holscher

**A**

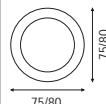

**Acabados**  
Inox AISI 316L mate + d line colors\*



**395002105**  
Knud Holscher

**B**



**Acabados**  
Inox AISI 316L mate + d line colors\*



**4053**  
Embutir

**A**

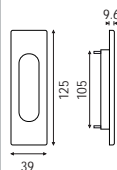

**Acabados**  
Titán y Negro



# MANILLONES Y TIRADORES DE PUERTA



**I4254**

Embutir

(B)

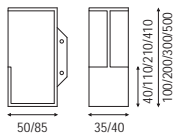

**Acabados**

Inox mate y Negro



**I4250**

Embutir

(B)

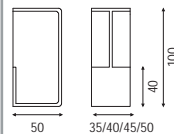

**Acabados**

Inox mate



**I3250**

Embutir

(B)

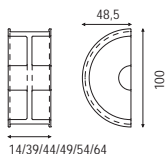

**Acabados**

Inox mate, Latón antiguo y Negro



**I4500 Slidlock**

Kit corredera embutir

(E)

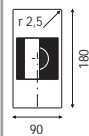

**Acabados**

Inox mate

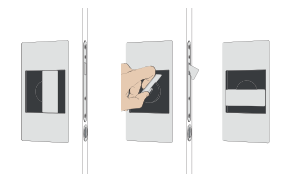

**I4258**

Embutir

(B)

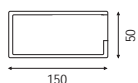

**Acabados**

Inox mate y Negro



**NO-HA mini**

Cerradura magnética con manilla invisible

(D)

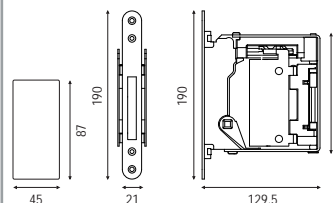

**Acabados**

Cromo mate





# MANILLONES Y TIRADORES DE PUERTA



**I4250/1**  
Kit corredera con cerradura

[B]

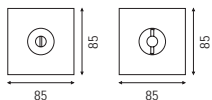

**Acabados**  
Inox mate

**I3255/1**  
Kit corredera con cerradura

[B]

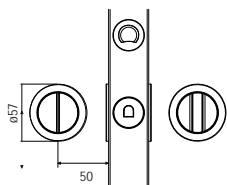

**Acabados**  
Negro

**I4255/1**  
Kit corredera con cerradura

[C]

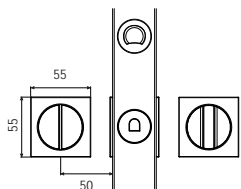

**Acabados**  
Negro

**30B0**  
Kit corredera paso

[A]

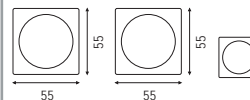
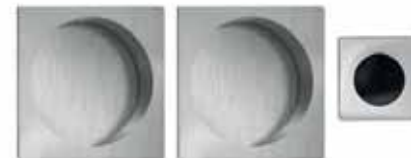

**Acabados**  
Cromo mate y Niquel mate

**3N061**  
Kit corredera con cerradura

[A]

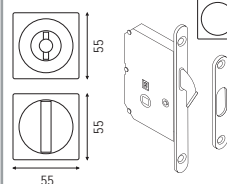

Para grueso de puerta 35-40  
**Acabados**  
Cromo mate y Niquel mate

**B7D**  
Kit corredera paso

[A]

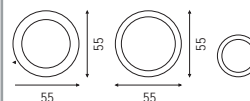

**Acabados**  
Cromo mate y Niquel mate

# MANILLONES Y TIRADORES DE PUERTA



## B71/B70 Kit corredera con cerradura

A

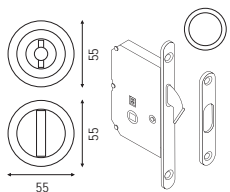

Para grueso de puerta 35-40 / 40-50

### Acabados

Cromo mate y Níquel mate



## K1232 Kit corredera paso

B

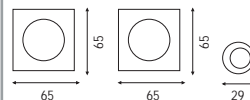

### Acabados

Cromo, Cromo mate, Latón pulido, Latón mate y Latón antiguo



## K1202 Kit corredera paso

B

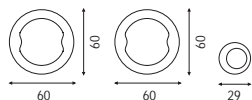

### Acabados

Cromo, Cromo mate, Latón pulido, Latón mate y Latón antiguo



## K1230 Kit corredera con cerradura

D

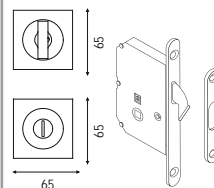

Para grueso de puerta 45

### Acabados

Cromo, Cromo mate, Latón pulido, Latón mate y Latón antiguo



## K1200 Kit corredera con cerradura

C

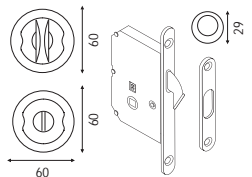

Para grueso de puerta 45

### Acabados

Cromo, Cromo mate, Latón pulido, Latón mate y Latón antiguo



## Servicio de fabricación a medida Formas / Acabados / Materiales / Medidas

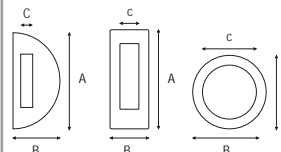

### Acabados

Latón pulido y barnizado, Latón mate, Latón natural, Latón patinado, Latón color cuero, Latón baño cromo brillo, Latón baño cromo mate, Latón baño níquel satinado y Latón baño níquel bruñido.



**I4020**  
Adhesivo

(A)

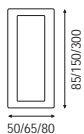

**Acabados**  
Inox mate  
Juego + uñero



**I4010**  
Adhesivo

(A)

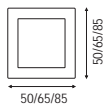

**Acabados**  
Inox mate  
Juego + uñero



**I4050**  
Adhesivo

(A)



**Acabados**  
Inox mate  
Juego + uñero



**I4030**  
Adhesivo

(A)

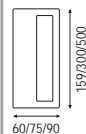

**Acabados**  
Inox mate  
Juego + uñero



**I4060**  
Adhesivo

(A)

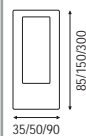

**Acabados**  
Inox mate  
Juego + uñero



**I3020**  
Adhesivo

(A)



**Acabados**  
Inox mate  
Juego + uñero



# MANILLONES Y TIRADORES DE PUERTA

**I3040**  
Adhesivo

(A)



**Acabados**  
Inox mate  
Juego + número



**I3030**  
Adhesivo

(A)

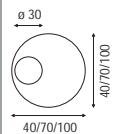

**Acabados**  
Inox mate  
Juego + número



**I3010**  
Adhesivo

(A)

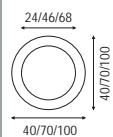

**Acabados**  
Inox mate  
Juego + número



DESCARGAR  
CATÁLOGO



04  
ACCESORIOS  
DE BAÑO

**2050121 / 2050121D (2 U.)**

ARCHITECT  
Colgador

(A)



**Acabados**

Cromo  
35 x 35 x 50 mm

(D)

**2050122**

ARCHITECT  
Colgador doble

(B)



**Acabados**

Cromo  
185 x 40 x 55 mm

**2050120**

ARCHITECT  
Portaguantes

(A)



**Acabados**

Cromo  
20 x 20 x 35 mm

**2050132 / 2050132D**

ARCHITECT  
Jabonera

(C)



**Acabados**

Cromo  
170 x 40 x 110 mm

(D)

**2050133 / 2050133D**

ARCHITECT  
Jabonera bañera

(C)



**Acabados**

Cromo  
170 x 40 x 110 mm

(D)

**2900239**

ARCHITECT  
Jabonera rejilla

(B)



**Acabados**

Inox brillo  
200 x 25 x 120 mm

2900230

ARCHITECT  
Jabonera rejilla rincón

**B**



**Acabados**  
Inox brillo  
180 x 25 mm

2050152 / 2050152D

ARCHITECT  
Portavasos

**C**



**Acabados**  
Cromo  
170 x 100 x 110 mm

2050144 / 2050144D  
2050145 / 2050145D

ARCHITECT  
Estante vidrio

**C**



**Acabados**  
Cromo y Vidrio  
430 x 40 x 110 mm / 600 x 40 x 110 mm

2050146 / 2050146D

ARCHITECT  
Estante

**C**



**Acabados**  
Inox brillo y Cromo  
430 x 40 x 110 mm

2050151 / 2050153 / 2050153D

ARCHITECT  
Portacepillos encimera / Portacepillos pared

**B**



**Acabados**  
Inox brillo y plástico  
62 x 62 x 135 mm

2050104 / 2050103 / 2050103D

ARCHITECT  
Dosificador encimera / Dosificador pared

**B**



**Acabados**  
Cromo  
62 x 183 x 87 mm

2050169

ARCHITECT  
Toallero

**B**



**Acabados**  
Cromo  
400 x 45 x 45 mm

2050167 / 2050167D

ARCHITECT  
Toallero

**B**



**Acabados**  
Cromo  
225 x 45 x 90 mm

2050184

ARCHITECT  
Espejo de aumento pared

**E**



**Acabados**  
Cromo  
275 x 255 x 45 mm

2900220

ARCHITECT  
Caja kleenex

**B**



**Acabados**  
Inox brillo  
258 x 127 x 90 mm

2050164 / 2050164D

ARCHITECT  
Toallero

**B**



**Acabados**  
Cromo  
415 x 45 x 85 mm / 590 x 45 x 85 mm / 780 x 45 x 85 mm

2050161 / 2050161D

ARCHITECT  
Toallero doble

**C**



**Acabados**  
Cromo  
590 x 45 x 130 mm

**2400175**

ARCHITECT  
Toallero doble giratorio

**D**



**Acabados**

Cromo  
440 x 60 x 65 mm

**2050171 / 2050171D**

ARCHITECT  
Toallero aro

**B**



**Acabados**

Cromo  
225 x 120 x 85 mm / 225 x 160 x 85 mm

**2900217**

ARCHITECT  
Asa abatible

**E**



**Acabados**

Cromo  
100 x 300 x 750 mm

**2050159 / 2050159D**

ARCHITECT  
Portapapel con tapa

**B**



**Acabados**

Cromo  
145 x 80 x 115 mm

**2900168 / 2900168D**

ARCHITECT  
Toallero estante

**E**



**Acabados**

Cromo  
575 x 95 x 260 mm

**2050168 / 2050168D**

ARCHITECT  
Toallero estante

**E**



**Acabados**

Cromo  
540 x 60 x 305 mm

**2050158 / 2050158D**

ARCHITECT  
Portapapel sin tapa

**B**



**Acabados**

Cromo  
160 x 45 x 90 mm

**2050196 / 2050196D**

ARCHITECT  
Portapapel vertical

**B**



**Acabados**

Cromo  
57 x 167 x 90 mm

**2900210**

ARCHITECT  
Asa bañera

**B**



**Acabados**

Cromo  
300 x 60 x 70 mm / 450 x 60 x 70 mm / 600 x 60 x 70 mm

**2900213 / 2900214**

ARCHITECT  
Asa bañera 135° derecha / izquierda

**D**



**Acabados**

Cromo  
490 x 240 x 70 mm

**2050157 / 2050157D**

ARCHITECT  
Portapapel doble sin tapa

**B**



**Acabados**

Cromo  
245 x 45 x 90 mm

**2900224 / 2900223**

ARCHITECT  
Escobillero suelo / Escobillero pared

**B**



**Acabados**

Inox brillo / Cromo  
92 x 386 x 92 mm / 92 x 386 x 94 mm

## 2050100 / 2050100D

ARCHITECT  
Escobillero pared

(C)



(D)

### Acabados

Inox brillo / Cromo  
92 x 386 x 92 mm / 92 x 386 x 94 mm

## 2900702 / 2900703

ARCHITECT  
Papelera

(A)



### Acabados

Inox brillo  
3 L - 170 x 245 x 220 mm / 5 L - 205 x 280 x 265 mm

## 2290533

BATH LIFE  
Bandeja

(A)



### Acabados

Blanco  
180 x 25 x 120 mm

## 2290140

BATH LIFE  
Barra estante

(C)



### Acabados

Cromo  
300 x 20 x 120 mm / 600 x 20 x 120 mm

## 2290121

BATH LIFE  
Colgador

(B)



### Acabados

Cromo  
20 x 70 x 20 mm

## 2290151 / 2290152

BATH LIFE  
Portacepillos encimera / Portacepillos pared

(C)



### Acabados

Cromo  
80 x 120 x 50 mm / 80 x 120 x 73 mm

## 2290545

BATH LIFE  
Estante para barra estante 2290140 y 2290160

(C)



### Acabados

Blanco  
300 x 15 x 120 mm

## 2290163

BATH LIFE  
Toallero

(C)



### Acabados

Cromo  
300 x 20 x 85 mm / 450 x 20 x 85 mm  
600 x 20 x 85 mm / 900 x 20 x 85 mm

## 2290104 / 2290105

BATH LIFE  
Dosificador encimera / Dosificador pared

(C)



### Acabados

Cromo  
80 x 150 x 82 mm / 80 x 150 x 104 mm

## 2290553

BATH LIFE  
Porta objetos

(B)



### Acabados

Blanco  
120 x 120 x 120 mm

## 2290174

BATH LIFE  
Toallero giratorio

(C)



### Acabados

Cromo  
400 x 30 x 140 mm

## 2290171

BATH LIFE  
Toallero aro

(C)



### Acabados

Cromo  
230 x 30 x 115 mm



**2290168**

BATH LIFE  
Toallero estante

**E**



**Acabados**

Cromo  
600 x 95 x 300 mm

**2290166**

BATH LIFE  
Toallero de pie

**E**



**Acabados**

Cromo  
600 x 720 x 250 mm

**2290100**

BATH LIFE  
Escobillero suelo / pared

**D**



**Acabados**

Blanco-Cromo  
90 x 500 x 90 mm

**2380621 / 2381521 / 2383621 / 2386521**

BLACK & WHITE  
Colgador

**B**



**Acabados**

Negro brillo, Blanco brillo, Negro mate, Blanco mate  
50 x 50 x 30 mm

**2290156**

BATH LIFE  
Portapapel con tapa

**D**



**Acabados**

Cromo  
120 x 60 x 120 mm

**2290159**

BATH LIFE  
Portapapel con tapa

**D**

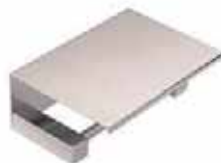

**Acabados**

Cromo  
160 x 60 x 120 mm

**2380620 / 2381521 / 2383620 / 2386520**

BLACK & WHITE  
Portaguantes

**A**



**Acabados**

Negro brillo, Blanco brillo, Negro mate, Blanco mate  
25 x 25 x 35 mm

**2510653 / 2510553 / 2513653 / 2516553**

BLACK & WHITE  
Portacepillos encimera  
Portacepillos pared

**B**



**Acabados**

Negro brillo, Blanco brillo, Negro mate, Blanco mate  
62 x 140 x 62 mm, 62 x 140 x 87 mm

**2290162**

BATH LIFE  
Portapapel sin tapa

**C**



**Acabados**

Cromo  
160 x 20 x 80 mm

**2290158**

BATH LIFE  
Portapapel sin tapa

**C**



**Acabados**

Cromo  
160 x 20 x 85 mm

**2510604 / 2510504 / 2513604 / 2516504**

BLACK & WHITE  
Dosificador encimera  
Dosificador pared

**C**



**Acabados**

Negro brillo, Blanco brillo, Negro mate, Blanco mate  
62 x 167 x 83 mm, 62 x 165 x 87 mm

**2510649 / 2510549 / 2513649 / 2516549**

BLACK & WHITE  
Container

**C**



**Acabados**

Negro brillo, Blanco brillo, Negro mate, Blanco mate  
300 x 40 x 120 mm

2510683 / 2510583 / 2513683 / 2516583

BLACK & WHITE  
Espejo aumento encimera (x3)

(A)



**Acabados**

Negro brillo, Blanco brillo, Negro mate, Blanco mate  
200 x 330 x 185 mm

2510685 / 2510585 / 2513685 / 2516585

BLACK & WHITE  
Espejo aumento (x3)

(D)



**Acabados**

Negro brillo, Blanco brillo, Negro mate, Blanco mate  
200 x 240 x 200 mm

2380659 / 2380559 / 2383659 / 2386559

BLACK & WHITE  
Portapapel con tapa

(C)



**Acabados**

Negro brillo, Blanco brillo, Negro mate, Blanco mate  
130 x 115 x 110 mm

2510658 / 2510558 / 2513658 / 2516558

BLACK & WHITE  
Portapapel sin tapa

(B)



**Acabados**

Negro brillo, Blanco brillo, Negro mate, Blanco mate  
170 x 25 x 85 mm

2380664 / 2381564 / 2383664 / 2386564

BLACK & WHITE  
Toallero

(C)



**Acabados**

Negro brillo, Blanco brillo, Negro mate, Blanco mate  
400 x 20 x 75 mm / 600 x 20 x 75 mm

2510675 / 2510575 / 2513675 / 2516575

BLACK & WHITE  
Toallero doble giratorio

(E)



**Acabados**

Negro brillo, Blanco brillo, Negro mate, Blanco mate  
410 x 75 x 55 mm

2380658 / 2381558 / 2383658 / 2386558

BLACK & WHITE  
Portapapel sin tapa

(B)



**Acabados**

Negro brillo, Blanco brillo, Negro mate, Blanco mate  
40 x 40 x 125 mm

2510600 / 2510500 / 2513600 / 2516500

BLACK & WHITE  
Escobillero suelo / pared

(D)



**Acabados**

Negro brillo, Blanco brillo,  
Negro mate, Blanco mate  
90 x 430 x 100 mm

2510671 / 2510571 / 2513671 / 2516571

BLACK & WHITE  
Toallero aro

(C)



**Acabados**

Negro brillo, Blanco brillo, Negro mate, Blanco mate  
200 x 150 x 50 mm

2510668 / 2510568 / 2513668 / 2516568

BLACK & WHITE  
Toallero estante

(E)



**Acabados**

Negro brillo, Blanco brillo, Negro mate, Blanco mate  
600 x 110 x 250 mm

2310121

CONTRACT  
Colgador

(A)



**Acabados**

Cromo  
25 x 25 x 35 mm

2310149

CONTRACT  
Container

(B)



**Acabados**

Cromo  
320 x 65 x 140 mm

**2310148**

CONTRACT  
Container

**C**



**Acabados**

Cromo  
420 x 115 x 140 mm

**2310164 / 2310165**

CONTRACT  
Toallero

**B**



**Acabados**

Cromo  
415 x 45 x 70 mm / 585 x 45 x 70 mm

**2510100**

CONTRACT  
Escobillero suelo / pared

**D**



**Acabados**

Cromo-blanco y Cromo-negro  
90 x 430 x 100 mm

**2530121**

EXTREME  
Colgador

**B**



**Acabados**

Cromo  
20 x 45 x 50 mm

**2310171 / 2310172**

CONTRACT  
Toallero aro

**B**



**Acabados**

Cromo  
160 x 180 x 70 mm / 210 x 230 x 70 mm

**2310159**

CONTRACT  
Portapapel con tapa

**B**



**Acabados**

Cromo  
130 x 125 x 80 mm

**2530132**

EXTREME  
Jabonera

**C**



**Acabados**

Cromo  
14 x 20 x 100 mm

**2530153 / 2530152**

EXTREME  
Portacepillos encimera / Portacepillos pared

**C**



**Acabados**

Cromo-negro  
80 x 120 x 50 mm / 80 x 120 x 60 mm

**2310158**

CONTRACT  
Portapapel sin tapa

**B**



**Acabados**

Cromo  
45 x 45 x 135 mm

**2310100**

CONTRACT  
Escobillero pared

**C**



**Acabados**

Cromo  
85 x 405 x 145 mm

**2530104 / 2530105**

EXTREME  
Dosificador encimera / Dosificador pared

**D**



**Acabados**

Cromo-negro  
80 x 160 x 75 mm / 80 x 160 x 85 mm

**2530144 / 2530145**

EXTREME  
Estante vidrio

**C**



**Acabados**

Cromo-vidrio templado  
400 x 55 x 100 mm / 600 x 55 x 100 mm

**2530168**

EXTREME  
Estante vidrio

**E**



**Acabados**

Cromo-vidrio templado  
600 x 55 x 260 mm

**2530163**

EXTREME  
Toallero

**C**



**Acabados**

Cromo  
300 x 35 x 70 mm / 450 x 35 x 70 mm  
600 x 35 x 70 mm / 800 x 35 x 70 mm

**2530101 / 2530100**

EXTREME  
Escobillero suelo / Escobillero pared

**E**



**Acabados**

Cromo-negro  
100 x 460 x 80 mm / 100 x 460 x 90 mm

**2260221 / 2260321**

LOGIC  
Colgador

**A**



**Acabados**

Inox brillo e Inox mate  
20 x 20 x 65 mm

**2530175**

EXTREME  
Toallero doble giratorio

**D**



**Acabados**

Cromo  
400 x 35 x 50 mm

**2530171**

EXTREME  
Toallero aro

**C**



**Acabados**

Cromo  
210 x 225 x 55 mm

**2250221 / 2250321**

LOGIC  
Colgador

**A**



**Acabados**

Inox brillo e Inox mate  
30 x 30 x 40 mm

**2260251 / 2260351 / 2260203 / 2260303**

LOGIC  
Portacepillos encimera / Portacepillos pared

**B**



**Acabados**

Inox brillo e Inox mate  
60 x 140 x 60 mm / 60 x 140 x 90 mm

**2510159**

EXTREME  
Portapapel con tapa

**C**



**Acabados**

Cromo  
140 x 80 x 130 mm

**2530158**

EXTREME  
Portapapel sin tapa

**B**



**Acabados**

Cromo  
150 x 40 x 70 mm

**2260253 / 2260353 / 2260204 / 2260304**

LOGIC  
Dosificador encimera / Dosificador pared

**B**



**Acabados**

Inox brillo e Inox mate  
60 x 165 x 85 mm / 60 x 165 x 110 mm

**2260245 / 2260345**

LOGIC  
Estante vidrio

**C**



**Acabados**

Inox brillo-vidrio e Inox mate-vidrio  
575 x 20 x 95 mm

2260246 / 2260346

LOGIC  
Estante Inox

**C**



**Acabados**

Inox brillo e Inox mate  
400 x 20 x 105 mm

2260243 / 2260343

LOGIC  
Estante rincón Inox

**C**



**Acabados**

Inox brillo e Inox mate  
235 x 20 x 235 mm

2260272 / 2260372

LOGIC  
Toallero aro

**B**



**Acabados**

Inox brillo e Inox mate  
200 x 120 x 30 mm

2260268 / 2260368

LOGIC  
Toallero estante

**E**



**Acabados**

Inox brillo e Inox mate  
500 x 95 x 310 mm

2260280 / 2260380

LOGIC  
Soportes estante (2)

**A**



**Acabados**

Inox brillo e Inox mate  
20 x 20 x 25 mm

2260264 / 2260364

LOGIC  
Toallero

**B**



**Acabados**

Inox brillo e Inox mate  
400 x 20 x 65 mm / 600 x 20 x 65 mm / 800 x 20 x 65 mm

2260259 / 2260359

LOGIC  
Portapapel con tapa

**B**



**Acabados**

Inox brillo e Inox mate  
130 x 60 x 135 mm

2250259 / 2250359

LOGIC  
Portapapel con tapa

**B**



**Acabados**

Inox brillo e Inox mate  
130 x 70 x 125 mm

2260261 / 2260361

LOGIC  
Toallero doble

**C**



**Acabados**

Inox brillo e Inox mate  
600 x 20 x 100 mm

2260274 / 2260374

LOGIC  
Toallero giratorio

**B**



**Acabados**

Inox brillo e Inox mate  
400 x 30 x 110 mm

2260258 / 2260358

LOGIC  
Portapapel sin tapa

**A**



**Acabados**

Inox brillo e Inox mate  
20 x 20 x 130 mm

2250258 / 2250358

LOGIC  
Portapapel sin tapa

**B**



**Acabados**

Inox brillo e Inox mate  
30 x 30 x 125 mm

**2260257 / 2260357**

LOGIC  
Portapapel doble sin tapa

**B**



**Acabados**

Inox brillo e Inox mate  
280 x 20 x 80 mm

**2260256 / 2260356**

LOGIC  
Portapapel sin tapa

**B**



**Acabados**

Inox brillo e Inox mate  
182 x 20 x 80 mm

**2510153 / 2510154**

MINIMALISM  
Portacepillos encimera / Portacepillos pared

**B**



**Acabados**

Cromo-negro  
60 x 140 x 60 mm / 60 x 140 x 90 mm

**2510104 / 2510105**

MINIMALISM  
Dosificador encimera / Dosificador pared

**C**



**Acabados**

Cromo  
60 x 165 x 85 mm / 60 x 165 x 110 mm

**2260254 / 2260354**

LOGIC  
Portapapel / Toallero aro

**B**



**Acabados**

Inox brillo e Inox mate  
155 x 95 x 30 mm

**2499800 / 2499600**

LOGIC  
Escobillero suelo / pared

**C**



**Acabados**

Inox brillo-negro e Inox mate-negro  
90 x 370 x 110 mm

**2400149**

MINIMALISM  
Container

**B**



**Acabados**

Cromo  
315 x 55 x 140 mm

**2400148**

MINIMALISM  
Container

**C**



**Acabados**

Cromo  
410 x 110 x 140 mm / 510 x 110 x 140 mm

**2260201 / 2260301**

**2260297 / 2260397**  
LOGIC  
Escobillero suelo / Escobillero pared

**B**



**Acabados**

Inox brillo e Inox mate  
92 x 386 x 92 mm / 92 x 386 x 94 mm

**2400121**

MINIMALISM  
Colgador

**A**



**Acabados**

Cromo  
25 x 25 x 65 mm

**2400150 / 2400189**

MINIMALISM  
Container rincón

**B**



**Acabados**

Cromo  
210 x 55 x 210 mm / 210 x 90 x 210 mm

**2400186**

MINIMALISM  
Espejo aumento

**C**



**Acabados**

Cromo  
260 x 20 x 325 mm

**2400145**  
MINIMALISM  
Estante de vidrio

(C)



**Acabados**  
Cromo-vidrio prensado  
575 x 30 x 95 mm

**2400146**  
MINIMALISM  
Estante

(C)



**Acabados**  
Cromo-Inox brillo  
400 x 30 x 105 mm

**2400175**  
MINIMALISM  
Toallero doble giratorio

(D)



**Acabados**  
Cromo  
440 x 70 x 65 mm

**2400171**  
MINIMALISM  
Toallero aro

(B)



**Acabados**  
Cromo  
160 x 170 x 50 mm / 210 x 220 x 50 mm

**2400143**  
MINIMALISM  
Estante rincón

(C)



**Acabados**  
Cromo-inox brillo  
220 x 30 x 220 mm

**2400180**  
MINIMALISM  
Soportes estante (2 U.)

(A)



**Acabados**  
Cromo  
20 x 20 x 25 mm

**2400168**  
MINIMALISM  
Toallero estante

(E)



**Acabados**  
Cromo  
540 x 65 x 300 mm

**2400159**  
MINIMALISM  
Portapapel con tapa

(B)



**Acabados**  
Cromo  
130 x 110 x 110 mm

**2400164**  
MINIMALISM  
Toallero

(C)



**Acabados**  
Cromo  
415 x 25 x 75 mm / 615 x 25 x 75 mm

**2400161**  
MINIMALISM  
Toallero doble

(D)



**Acabados**  
Cromo  
615 x 25 x 110 mm

**2400189**  
MINIMALISM  
Portapapel sin tapa

(B)



**Acabados**  
Cromo  
35 x 35 x 125 mm

**2400100**  
MINIMALISM  
Escobillero pared

(C)

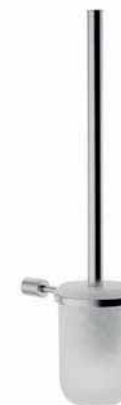

**Acabados**  
Cromo  
90 x 400 x 145 mm

**2510121**

PROJECT  
Colgador

**A**



**Acabados**

Cromo  
20 x 70 x 35 mm

**2515134 / 2516134**

PROJECT  
Jabonera encimera

**B**



**Acabados**

Cromo-blanco y Cromo-negro  
115 x 115 x 10 mm

**2515150 / 2516150**

PROJECT  
Container rincón

**C**



**Acabados**

Cromo-blanco y Cromo-negro  
220 x 40 x 220 mm

**2515183 / 2516183**

PROJECT  
Espejo aumento encimera

**D**



**Acabados**

Cromo-blanco y Cromo-negro  
200 x 330 x 185 mm

**2515132 / 2516132**

PROJECT  
Jabonera pared

**C**



**Acabados**

Cromo-blanco y Cromo-negro  
100 x 115 x 45 mm

**2510153 / 2510154**

PROJECT  
Portacepillos encimera / Portacepillos pared

**B**



**Acabados**

Cromo-negro  
60 x 140 x 60 mm / 60 x 140 x 90 mm

**2515185 / 2516185**

PROJECT  
Espejo aumento

**D**



**Acabados**

Cromo-blanco y Cromo-negro  
240 x 200 x 200 mm

**2510144**

PROJECT  
Estante vidrio

**C**



**Acabados**

Cromo-vidrio templado  
400 x 20 x 100 mm / 600 x 20 x 100 mm

**2510104 / 2510105**

PROJECT  
Dosificador encimera / Dosificador pared

**C**



**Acabados**

Cromo  
60 x 165 x 85 mm / 60 x 165 x 110 mm

**2515149 / 2516149**

PROJECT  
Container

**C**



**Acabados**

Cromo-blanco y Cromo-negro  
300 x 40 x 120 mm

**2510162**

PROJECT  
Toallero

**B**



**Acabados**

Cromo  
235 x 25 x 80 mm

**2510164**

PROJECT  
Toallero

**C**



**Acabados**

Cromo  
400 x 25 x 80 mm / 600 x 25 x 80 mm / 800 x 25 x 80 mm



**2510175**  
PROJECT  
Toallero doble giratorio

(D)



**Acabados**  
Cromo  
410 x 75 x 55 mm

**2510171**  
PROJECT  
Toallero aro

(C)



**Acabados**  
Cromo  
200 x 150 x 50 mm / 200 x 200 x 50 mm / 300 x 150 x 50 mm

**2510158**  
PROJECT  
Portapapel sin tapa

(B)



**Acabados**  
Cromo  
170 x 25 x 85 mm

**2510157**  
PROJECT  
Portapapel doble sin tapa

(C)



**Acabados**  
Cromo  
290 x 30 x 80 mm

**2510168**  
PROJECT  
Toallero estante

(E)



**Acabados**  
Cromo  
600 x 110 x 250 mm

**2510167**  
PROJECT  
Toallero pie

(E)



**Acabados**  
Cromo  
600 x 800 x 200 mm

**2510196**  
PROJECT  
Portapapel vertical

(B)



**Acabados**  
Cromo  
75 x 185 x 110 mm

**2510100**  
PROJECT  
Escobillero suelo / pared

(D)



**Acabados**  
Cromo-blanco y Cromo-negro  
90 x 430 x 110 mm

**2510124 / 2510125 / 2510198 / 2510199**  
PROJECT  
Asa bañera

(D)



**Acabados**  
Cromo  
400/600/800/1000 x 30 x 70 mm

**2510159**  
PROJECT  
Portapapel con tapa

(C)



**Acabados**  
Cromo  
140 x 80 x 130 mm

**2510197**  
PROJECT  
Escobillero / portapapel suelo

(E)



**Acabados**  
Cromo  
275 x 650 x 200 mm

**2680121 / 2686521 / 2683621**  
THE GRID  
Colgador

(A)



**Acabados**  
Cromo, Blanco mate y Negro mate  
110 x 16 x 30 mm

2680104 / 2686504 / 2683604  
2680105 / 2686505 / 2683605

THE GRID  
Dosificador / portacepillos encimera / pared

(B)



**Acabados**

Cromo, Blanco mate y Negro mate  
127 x 110 x 145 mm / 138 x 110 x 145 mm

2680553

THE GRID  
Portacepillos doble

(B)



**Acabados**

Blanco mate  
124 x 110 x 110 mm

2680159 / 2686559 / 2683659

THE GRID  
Portapapel con tapa

(C)



**Acabados**

Cromo, Blanco mate y Negro mate  
65 x 140 x 130 mm

2680158 / 2686558 / 2683658

THE GRID  
Portapapel sin tapa

(B)



**Acabados**

Cromo, Blanco mate y Negro mate  
22 x 140 x 85 mm

2680163 / 2686563 / 2683663

THE GRID  
Toallero repisa / container

(E)



**Acabados**

Cromo, Blanco mate y Negro mate  
110 x 350 x 110 mm / 110 x 550 x 110 mm

2680171 / 2686571 / 2653671

THE GRID  
Toallero aro

(B)



**Acabados**

Cromo, Blanco mate y Negro mate  
110 x 203 x 16 mm

2680101 / 2686501 / 2683601

THE GRID  
Escobillero suelo

(D)



**Acabados**

Cromo, Blanco mate y Negro mate  
480 x 110 x 110 mm

2680100 / 2686500 / 2683600

THE GRID  
Escobillero suelo / pared

(E)



**Acabados**

Cromo, Blanco mate y Negro mate  
590 x 110 x 110 mm

2680174 / 2686574 / 2683674

THE GRID  
Toallero giratorio

(C)



**Acabados**

Cromo, Blanco mate y Negro mate  
110 x 403 x 16 mm

2680168 / 2686568 / 2683668

THE GRID  
Toallero estante

(E)



**Acabados**

Cromo, Blanco mate y Negro mate  
120 x 550 x 300 mm

2380121

WORKING  
Colgador

(B)



**Acabados**

Cromo  
50 x 50 x 30 mm

2380120

WORKING  
Portaguantes

(A)



**Acabados**

Cromo  
25 x 25 x 35 mm

**2380186**

WORKING  
Container

**B**



**Acabados**

Cromo  
200 x 40 x 120 mm

**2380149**

WORKING  
Container

**C**



**Acabados**

Cromo  
300 x 65 x 120 mm

**2380171**

WORKING  
Toallero aro

**B**



**Acabados**

Cromo  
225 x 125 x 40 mm

**2380159**

WORKING  
Portapapel con tapa

**B**



**Acabados**

Cromo  
130 x 115 x 110 mm

**2380148**

WORKING  
Container

**D**



**Acabados**

Cromo  
400 x 105 x 120 mm / 500 x 105 x 120 mm

**2380150**

WORKING  
Container rincón

**B**



**Acabados**

Cromo  
275 x 65 x 200 mm

**2380158**

WORKING  
Portapapel sin tapa

**B**



**Acabados**

Cromo  
40 x 40 x 125 mm

**2510100**

WORKING  
Escobillero suelo / pared

**D**



**Acabados**

Cromo  
90 x 430 x 100 mm

**2380164**

WORKING  
Toallero

**C**



**Acabados**

Cromo  
400 x 20 x 75 mm / 600 x 20 x 75 mm / 800 x 20 x 75 mm

**2380174**

WORKING  
Toallero giratorio

**C**



**Acabados**

Cromo  
415 x 90 x 40 mm

**2690121**

LINE  
Colgador

**A**



**Acabados**

Cromo  
30 x 110 x 29 mm

**D**

**2690153**

LINE  
Portaceillos encimera

**A**



**Acabados**

Cromo  
63 x 137 x 63 mm

**2690104**

LINE  
Dosificador encimera

**B**



**Acabados**

Cromo  
63 x 160 x 64 mm

**2690149**

LINE  
Container

**B**



**Acabados**

Cromo  
300 x 80 x 106 mm

**2690159**

LINE  
Portapapel con tapa

**B**



**Acabados**

Cromo  
152 x 80 x 110 mm

**2690158**

LINE  
Portapapel sin tapa

**A**



**Acabados**

Cromo  
152 x 30 x 64 mm

**2690150**

LINE  
Container rincón

**B**



**Acabados**

Cromo  
200 x 80 x 200 mm

**2690164**

LINE  
Toallero

**B**



**Acabados**

Cromo  
400 x 30 x 65 mm / 600 x 30 x 65 mm

**2690100**

LINE  
Escobillero suelo

**B**



**Acabados**

Cromo  
93 x 356 x 92 mm

**2690102 / 2690202**

LINE  
Papelera

**C**



**Acabados**

Cromo e Inox brillo  
5 L - 205 x 300 x 205 mm

**2690171**

LINE  
Toallero aro

**B**



**Acabados**

Cromo  
210 x 105 x 30 mm

**2690168**

LINE  
Toallero estante

**D**



**Acabados**

Cromo  
500 x 85 x 214 mm

**2750121 / 2756521 / 2753621**

DIABOLO  
Colgador

**A**



**Acabados**

Cromo, Blanco mate y Negro mate  
50 x 50 x 38 mm

**2751664 / 2755664 / 2756664**

DIABOLO  
Toallero

**B**



**Acabados**

Base: Cromo, Blanco mate y Negro mate  
Cuerda: Roja, Blanca y Negra  
50 x 50 x 17 mm

**2751658 / 2755658 / 2756658**

DIABOLO  
Portapapel sin tapa

**A**



**Acabados**

Base: Cromo, Blanco mate y Negro mate  
Cuerda: Roja, Blanca y Negra  
50 x 50 x 17 mm

**A**

**2620121**

DUO ROUND  
Colgador

**A**



**Acabados**

Cromo  
55 x 55 x 50 mm

**A**

**2620149**

DUO ROUND  
Jabonera rejilla

**B**



**Acabados**

Cromo  
150 x 55 x 110 mm

**A**

**2620130**

DUO ROUND  
Container

**B**



**Acabados**

Cromo  
200 x 55 x 110 mm / 300 x 70 x 130 mm / 400 x 60 x 130 mm

**A**

**2620132**

DUO ROUND  
Jabonera

**A**



**Acabados**

Cromo  
110 x 55 x 130 mm

**A**

**2620152**

DUO ROUND  
Portacepillos

**A**



**Acabados**

Cromo-vidrio prensado  
75 x 120 x 110 mm

**A**

**2620142**

DUO ROUND  
Container

**C**



**Acabados**

Cromo  
300 x 130 x 130 mm

**A**

**2620187 / 2620188**

DUO ROUND  
Container escalón derecho / izquierdo

**B**



**Acabados**

Cromo  
300 x 80 x 130 mm

**A**

**2620105**

DUO ROUND  
Dosificador

**A**



**Acabados**

Cromo-vidrio prensado  
75 x 160 x 120 mm

**A**

**2620104**

DUO ROUND  
Dosificador

**C**



**Acabados**

Cromo  
60 x 185 x 100 mm

**A**

**2620150**

DUO ROUND  
Container rincón

**B**



**Acabados**

Cromo  
210 x 80 x 210 mm / 260 x 80 x 260 mm / 260 x 130 x 260 mm

**A**

**2620144**

DUO ROUND  
Estante vidrio

**B**



**Acabados**

Cromo  
400 x 55 x 100 mm / 600 x 55 x 100 mm

**A**

**2620163**

DUO ROUND  
Toallero

**B**



**Acabados**

Cromo  
300 x 55 x 70 mm / 450 x 55 x 70 mm / 600 x 55 x 70 mm



**2620172**

DUO ROUND  
Toallero aro

**B**



**Acabados**

Cromo  
200 x 220 x 50 mm



**2620101**

DUO ROUND  
Escobillero pared

**C**



**Acabados**

Cromo  
90 x 415 x 110 mm



**2640121**

DUO SQUARE  
Colgador

**A**



**Acabados**

Cromo  
50 x 50 x 50 mm



**2620168**

DUO ROUND  
Toallero estante

**C**



**Acabados**

Cromo  
610 x 55 x 200 mm



**2620159**

DUO ROUND  
Portapapel con tapa

**A**



**Acabados**

Cromo  
125 x 130 x 50 mm



**2640132**

DUO SQUARE  
Jabonera

**A**



**Acabados**

Cromo-vidrio prensado  
110 x 50 x 130 mm



**2640152**

DUO SQUARE  
Portacepillos

**A**



**Acabados**

Cromo-vidrio prensado  
75 x 120 x 110 mm



**2620156 / 2620157**

DUO ROUND  
Portapapel sin tapa derecho / izquierdo

**A**



**Acabados**

Cromo  
170 x 55 x 75 mm



**2620100**

DUO ROUND  
Escobillero pared

**B**



**Acabados**

Cromo-vidrio prensado  
75 x 380 x 110 mm



**2640105**

DUO SQUARE  
Dosificador

**A**



**Acabados**

Cromo-vidrio prensado  
75 x 160 x 120 mm



**2640104**

DUO SQUARE  
Dosificador

**C**



**Acabados**

Cromo  
60 x 185 x 100 mm



**2640149**

DUO SQUARE  
Jabonera rejilla

(B)



**Acabados**

Cromo  
150 x 55 x 110 mm



**2640130**

DUO SQUARE  
Container

(B)

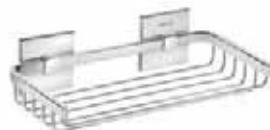

**Acabados**

Cromo  
200 x 55 x 110 mm / 300 x 70 x 130 mm / 400 x 60 x 130 mm



**2640163**

DUO SQUARE  
Toallero

(B)



**Acabados**

Cromo  
300 x 50 x 70 mm / 450 x 50 x 70 mm / 600 x 50 x 70 mm



**2640172**

DUO SQUARE  
Toallero aro

(B)



**Acabados**

Cromo  
200 x 220 x 50 mm



**2640142**

DUO SQUARE  
Container

(C)



**Acabados**

Cromo  
300 x 130 x 130 mm



**2640187 / 2640188**

DUO SQUARE  
Container escalón derecho / izquierdo

(B)

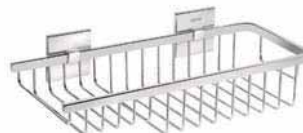

**Acabados**

Cromo  
300 x 80 x 130 mm



**2640168**

DUO SQUARE  
Toallero estante

(C)



**Acabados**

Cromo  
605 x 50 x 195 mm



**2640159**

DUO SQUARE  
Portapapel con tapa

(A)



**Acabados**

Cromo  
125 x 130 x 50 mm



**2640150**

DUO SQUARE  
Container rincón

(B)



**Acabados**

Cromo  
210 x 80 x 210 mm / 260 x 80 x 260 mm / 260 x 130 x 260 mm



**2640144 / 2640145**

DUO SQUARE  
Estante vidrio

(B)



**Acabados**

Cromo-vidrio prensado  
400 x 50 x 100 mm / 600 x 50 x 100 mm



**2640156 / 2640157**

DUO SQUARE  
Portapapel sin tapa derecho / izquierdo

(A)



**Acabados**

Cromo  
170 x 50 x 75 mm



**2640100**

DUO SQUARE  
Escobillero pared

(B)



**Acabados**

Cromo-vidrio prensado  
75 x 380 x 110 mm



**2640101**  
DUO SQUARE  
Escobillero pared

**C**



**Acabados**  
Cromo  
90 x 415 x 110 mm

**A**

**2760123 / 2763623 / 2766523**  
STICK  
Colgador

**A**



**Acabados**  
Cromo, Negro mate, Blanco mate  
25 x 70 x 66 mm

**A**

**2760149 / 2763649 / 2766549**  
STICK  
Container

**C**



**Acabados**  
Cromo, Negro mate, Blanco mate  
304 x 96 x 118 mm

**A**

**2760144 / 2763644 / 2766544**  
STICK  
Estante vidrio

**B**



**Acabados**  
Cromo, Negro mate, Blanco mate  
400 x 45 x 102 mm

**A**

**2760121 / 2763621 / 2766521**  
STICK  
Colgador

**A**



**Acabados**  
Cromo, Negro mate, Blanco mate  
45 x 45 x 44 mm

**A**

**2760122 / 2763622 / 2766522**  
STICK  
Colgador doble

**A**



**Acabados**  
Cromo, Negro mate, Blanco mate  
110 x 45 x 44 mm

**A**

**2760163 / 2763663 / 2766563**  
STICK  
Toallero

**B**



**Acabados**  
Cromo, Negro mate, Blanco mate  
300 x 45 x 68 mm / 450 x 45 x 68 mm / 600 x 45 x 68 mm

**A**

**2760166 / 2763666 / 2766566**  
STICK  
Toallero

**B**



**Acabados**  
Cromo, Negro mate, Blanco mate  
280 x 70 x 67 mm / 380 x 70 x 67 mm

**A**

**2760153 / 2763653 / 2766553**  
STICK  
Portacepillos

**A**



**Acabados**  
Cromo, Negro mate, Blanco mate  
76 x 116 x 108 mm

**A**

**2760103 / 2763603 / 2766503**  
STICK  
Dosificador

**B**



**Acabados**  
Cromo, Negro mate, Blanco mate  
76 x 164 x 118 mm

**A**

**2760169 / 2763669 / 2766569**  
STICK  
Toallero

**B**



**Acabados**  
Cromo, Negro mate, Blanco mate  
45 x 80 x 309 mm

**A**

**2760171 / 2763671 / 2766571**  
STICK  
Toallero aro

**B**



**Acabados**  
Cromo, Negro mate, Blanco mate  
255 x 70 x 100 mm

**A**



2760159 / 2763659 / 2766559

STICK  
Portapapel con tapa

(B)



**Acabados**

Cromo, Negro mate, Blanco mate  
125 x 115 x 59 mm

▲

2760158 / 2763658 / 2766558

STICK  
Portapapel sin tapa

(A)



**Acabados**

Cromo, Negro mate, Blanco mate  
152 x 45 x 76 mm

▲

433011002 / 433011002D (2 U.)

KUBIC CLASS  
Colgador

(A)



**Acabados**

Cromo  
35 x 35 x 35 mm

363001002 / 363001002D (2 U.)

KUBIC  
Colgador

(B)



**Acabados**

Cromo  
50 x 50 x 80 mm

2760196 / 2763696 / 2766596

STICK  
Portapapel sin tapa

(A)



**Acabados**

Cromo, Negro mate, Blanco mate  
45 x 45 x 144 mm

▲

2760101 / 2763601 / 2766501

STICK  
Escobillero pared

(B)



**Acabados**

Cromo, Negro mate, Blanco mate  
76 x 383 x 107 mm

▲

333001002 / 333001002D (2 U.)

KUBIC COOL  
Colgador

(B)



**Acabados**

Cromo  
50 x 50 x 80 mm

433001002 / 433001002D (2 U.)

KUBIC CLASS  
Colgador

(B)



**Acabados**

Cromo  
50 x 50 x 80 mm

363011002 / 363011002D (2 U.)

KUBIC  
Colgador

(A)



**Acabados**

Cromo  
35 x 35 x 40 mm

●

333011002 / 333011002D (2 U.)

KUBIC COOL  
Colgador

(A)



**Acabados**

Cromo  
35 x 35 x 40 mm

●

363002002 / 363002002D

KUBIC  
Colgador doble

(B)



**Acabados**

Cromo  
90 x 50 x 80 mm

333002002 / 333002002D

KUBIC COOL  
Colgador doble

(B)



**Acabados**

Cromo  
90 x 50 x 70 mm

## 433002002 / 433002002D

KUBIC CLASS  
Colgador doble

**B**



### Acabados

Cromo  
90 x 50 x 80 mm

**D**

## 366052002

KUBIC / KUBIC COOL / KUBIC CLASS  
Jabonera encimera

**C**



### Acabados

Cromo  
105 x 25 x 120 mm

## 366032002

KUBIC / KUBIC COOL / KUBIC CLASS  
Jabonera rincón

**D**



### Acabados

Cromo  
230 x 30 x 230 mm

## 367050002

KUBIC / KUBIC COOL / KUBIC CLASS  
Portacepillos encimera

**C**



### Acabados

Cromo  
90 x 110 x 90 mm

## 366003002 / 366003002D

KUBIC / KUBIC COOL / KUBIC CLASS  
Jabonera pared

**C**



### Acabados

Cromo  
105 x 45 x 125 mm

**D**

## 366020002 / 366020002D

KUBIC  
Jabonera ducha

**E**



### Acabados

Cromo  
320 x 90 x 130 mm

**D**

## 367002002 / 367002002D

KUBIC / KUBIC COOL / KUBIC CLASS  
Portacepillos pared

**C**



### Acabados

Cromo  
80 x 110 x 110 mm

**D**

## 367832002

KUBIC / KUBIC COOL / KUBIC CLASS  
Dosificador encimera

**D**



### Acabados

Cromo  
90 x 230 x 90 mm

## 336020002 / 336020002D

KUBIC COOL  
Jabonera ducha

**E**



### Acabados

Cromo  
320 x 90 x 130 mm

**D**

## 436020002 / 436020002D

KUBIC CLASS  
Jabonera ducha

**E**



### Acabados

Cromo  
320 x 90 x 130 mm

**D**

## 367831002

KUBIC / KUBIC COOL / KUBIC CLASS  
Dosificador encimera

**C**



### Acabados

Cromo  
70 x 200 x 70 mm

## 367805002 / 367805002D

KUBIC / KUBIC COOL / KUBIC CLASS  
Dosificador pared

**D**



### Acabados

Cromo  
70 x 200 x 90 mm

**D**

**365040002 / 365040002D**

KUBIC  
Estante de vidrio

**C**



**Acabados**

Cromo-vidrio  
400 x 50 x 150 mm / 600 x 50 x 150 mm

**D**

**335040002 / 335040002D**

KUBIC COOL  
Estante de vidrio

**C**



**Acabados**

Cromo-vidrio  
400 x 50 x 150 mm / 600 x 50 x 150 mm

**D**

**361442002 / 361442002D**

KUBIC  
Toallero doble

**D**



**Acabados**

Cromo  
600 x 50 x 110 mm

**D**

**331442002 / 331442002D**

KUBIC COOL  
Toallero doble

**D**



**Acabados**

Cromo  
600 x 50 x 110 mm

**D**

**435040002 / 435040002D**

KUBIC CLASS  
Estante de vidrio

**C**



**Acabados**

Cromo-vidrio  
400 x 40 x 150 mm / 600 x 50 x 150 mm

**D**

**361030002 / 361030002D**

KUBIC  
Toallero

**B**



**Acabados**

Cromo  
300/400/500/600 x 50 x 90 mm

**D**

**431442002 / 431442002D**

KUBIC CLASS  
Toallero doble

**D**



**Acabados**

Cromo  
600 x 50 x 110 mm

**D**

**361401002 / 361401002D**

KUBIC  
Toallero lateral doble

**C**



**Acabados**

Cromo  
50 x 130 x 360 mm

**D**

**331030002 / 331030002D**

KUBIC COOL  
Toallero

**B**



**Acabados**

Cromo  
300/400/500/600 x 50 x 90 mm

**D**

**431030002 / 431030002D**

KUBIC CLASS  
Toallero

**B**



**Acabados**

Cromo  
300/400/500/600 x 50 x 90 mm

**D**

**331401002 / 331401002D**

KUBIC COOL  
Toallero lateral doble

**C**



**Acabados**

Cromo  
50 x 130 x 360 mm

**D**

**431401002 / 431401002D**

KUBIC CLASS  
Toallero lateral doble

**C**



**Acabados**

Cromo  
50 x 130 x 360 mm

**D**

**362055002 / 362055002D**

KUBIC  
Toallero aro

**C**



**Acabados**

Cromo  
250 x 130 x 90 mm

**D**

**332055002 / 332055002D**

KUBIC COOL  
Toallero aro

**C**



**Acabados**

Cromo  
250 x 130 x 90 mm

**D**

**365110002 / 365110002D**

KUBIC  
Toallero estante

**E**

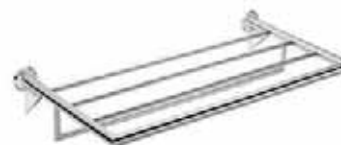

**Acabados**

Cromo  
600 x 90 x 270 mm

**D**

**335110002 / 335110002D**

KUBIC COOL  
Toallero estante

**E**

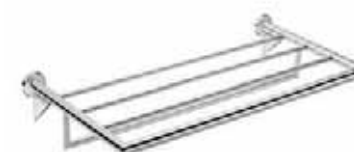

**Acabados**

Cromo  
600 x 90 x 270 mm

**D**

**332055002 / 332055002D**

KUBIC CLASS  
Toallero aro

**C**



**Acabados**

Cromo  
250 x 130 x 90 mm

**D**

**362057002 / 362057002D**

KUBIC  
Toallero aro

**C**



**Acabados**

Cromo  
230 x 140 x 75 mm

**D**

**435110002 / 435110002D**

KUBIC CLASS  
Toallero estante

**E**



**Acabados**

Cromo  
600 x 90 x 270 mm

**D**

**361204002**

KUBIC / KUBIC COOL / KUBIC CLASS  
Toallero de pie

**E**



**Acabados**

Cromo  
380 x 840 x 300 mm

**332057002 / 332057002D**

KUBIC COOL  
Toallero aro

**C**



**Acabados**

Cromo  
230 x 140 x 75 mm

**D**

**432057002 / 432057002D**

KUBIC CLASS  
Toallero aro

**C**



**Acabados**

Cromo  
230 x 140 x 75 mm

**D**

**360536002**

KUBIC / KUBIC COOL / KUBIC CLASS  
Asa bañera

**C**



**Acabados**

Cromo  
350 x 60 x 100 mm

**140535002**

KUBIC / KUBIC COOL / KUBIC CLASS  
Asa bañera

**C**



**Acabados**

Cromo  
350 x 60 x 90 mm / 500 x 60 x 90 mm / 650 x 60 x 90 mm

**364005002 / 364005002D**  
KUBIC / KUBIC COOL / KUBIC CLASS  
Portapapel con tapa derecho

(C)



**Acabados**  
Cromo  
140 x 90 x 130 mm

(D)

**364012002 / 364012002D**  
KUBIC / KUBIC COOL / KUBIC CLASS  
Portapapel con tapa izquierdo

(C)



**Acabados**  
Cromo  
140 x 90 x 130 mm

(D)

**331481002 / 331481002D**  
KUBIC COOL  
Portapapel sin tapa

(B)



**Acabados**  
Cromo  
170 x 50 x 90 mm

(D)

**431481002 / 431481002D**  
KUBIC CLASS  
Portapapel sin tapa

(B)



**Acabados**  
Cromo  
170 x 50 x 90 mm

(D)

**364042002 / 364042002D**  
KUBIC  
Portapapel vertical

(B)



**Acabados**  
Cromo  
60 x 170 x 90 mm

(D)

**334042002 / 334042002D**  
KUBIC COOL  
Portapapel vertical

(B)



**Acabados**  
Cromo  
60 x 170 x 90 mm

(D)

**431481002**  
KUBIC / KUBIC COOL / KUBIC CLASS  
Escobillero suelo

(E)



**Acabados**  
Cromo  
100 x 330 x 110 mm

**369002002 / 369002002D**  
KUBIC / KUBIC COOL / KUBIC CLASS  
Escobillero pared

(E)



**Acabados**  
Cromo  
100 x 330 x 120 mm

(D)

**434042002 / 434042002D**  
KUBIC CLASS  
Portapapel vertical

(B)



**Acabados**  
Cromo  
60 x 170 x 90 mm

(D)

**361481002 / 361481002D**  
KUBIC  
Portapapel sin tapa

(B)



**Acabados**  
Cromo  
170 x 50 x 90 mm

(D)

**361904002**  
KUBIC / KUBIC COOL / KUBIC CLASS  
Escobillero / Portapapel suelo

(E)



**Acabados**  
Cromo  
280 x 610 x 180 mm

**369351002**  
KUBIC / KUBIC COOL / KUBIC CLASS  
Papelera

(E)



**Acabados**  
Cromo  
170 x 290 x 170 mm

**493001002**

URBAN  
Colgador

**A**



**Acabados**

Cromo  
55 x 36 x 24 mm

**496050002NE / 496050002TR**

URBAN  
Jabonera encimera

**E**



**Acabados**

Cromo-vidrio negro y Cromo-vidrio transparente  
165 x 30 x 90 mm

**495040002NE / 495040002TR**

URBAN  
Estante

**E**



**Acabados**

Cromo-vidrio negro y Cromo-vidrio transparente  
400 x 25 x 120 mm

**491030002**

URBAN  
Toallero

**C**



**Acabados**

Cromo  
300 x 25 x 70 mm / 400 x 25 x 70 mm / 600 x 25 x 70 mm

**496001002NE / 496001002TR**

URBAN  
Jabonera pared

**E**

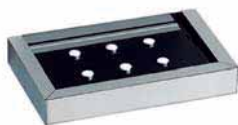

**Acabados**

Cromo-vidrio negro y Cromo-vidrio transparente  
160 x 25 x 100 mm

**496020002**

URBAN  
Jabonera ducha

**E**



**Acabados**

Cromo  
400 x 115 x 120 mm

**491401002**

URBAN  
Toallero doble giratorio

**E**



**Acabados**

Cromo  
10 x 75 x 360 mm

**492055002**

URBAN  
Toallero aro

**C**



**Acabados**

Cromo  
220 x 25 x 100 mm

**497050002 / 497001002**

URBAN  
Portacepillos encimera / Portacepillos pared

**C**



**Acabados**

Cromo  
80 x 121 x 55 mm / 80 x 121 x 75 mm

**497831002 / 497801002**

URBAN  
Dosificador encimera / Dosificador pared

**C**



**Acabados**

Cromo  
80 x 170 x 50 mm / 80 x 170 x 76 mm

**495110002**

URBAN  
Toallero estante

**E**



**Acabados**

Cromo  
600 x 125 x 305 mm

**494002002**

URBAN  
Portapapel con tapa

**D**



**Acabados**

Cromo  
135 x 70 x 125 mm

**494001002 / 494010002**

URBAN  
Portapapel sin tapa derecho / izquierdo

**B**



**Acabados**

Cromo  
150 x 35 x 70 mm

**499050002 / 499001002**

URBAN  
Escobillero suelo / Escobillero pared

**E**



**Acabados**

Cromo  
85 x 500 x 85 mm / 85 x 500 x 65 mm

**476020002**

MICRA  
Jabonera ducha

**D**



**Acabados**

Cromo  
300 x 90 x 120 mm

**477050002 / 477001002**

MICRA  
Portacepillos encimera / Portacepillos pared

**C**



**Acabados**

Cromo  
70 x 160 x 100 mm

**473001002**

MICRA  
Colgador

**A**



**Acabados**

Cromo  
10 x 20 x 50 mm

**473003002**

MICRA  
Colgador

**D**



**Acabados**

Cromo  
10 x 140 x 90 mm

**477832002 / 477802002**

MICRA  
Dosificador encimera / Dosificador pared

**D**



**Acabados**

Cromo  
60 x 217 x 85 mm  
60 x 217 x 105 mm

**149403002**

MICRA  
Caja kleenex

**D**



**Acabados**

Cromo  
250 x 60 x 130 mm

**473002002**

MICRA  
Colgador doble

**B**



**Acabados**

Cromo  
80 x 20 x 50 mm

**476050002 / 476001002**

MICRA  
Jabonera encimera / Jabonera pared

**C**



**Acabados**

Cromo  
140 x 14 x 120 mm / 140 x 14 x 100 mm

**475040002**

MICRA  
Estante

**D**



**Acabados**

Cromo  
400 x 14 x 130 mm

**471030002**

MICRA  
Toallero

**B**



**Acabados**

Cromo  
300 x 14 x 70 mm / 400 x 14 x 70 mm / 500 x 14 x 70 mm

**471443002**

MICRA  
Toallero doble / Colgador

(E)



**Acabados**

Cromo  
500 x 80 x 130 mm

**471401002**

MICRA  
Toallero doble lateral

(D)



**Acabados**

Cromo  
10 x 162 x 360 mm

**479050002**

MICRA  
Escobillero suelo

(E)



**Acabados**

Cromo  
90 x 500 x 90 mm

**479001002**

MICRA  
Escobillero pared

(E)



**Acabados**

Cromo  
90 x 500 x 80 mm

**472055002**

MICRA  
Toallero aro

(C)



**Acabados**

Cromo  
230 x 105 x 60 mm

**475110002**

MICRA  
Toallero estante

(E)



**Acabados**

Cromo  
500 x 80 x 254 mm

**383001002 / 383001021**

METRIC  
Colgador

(A)



**Acabados**

Cromo e Inox mate  
20 x 20 x 40 mm

**383002002 / 383002021**

METRIC  
Colgador doble

(B)



**Acabados**

Cromo e Inox mate  
20 x 80 x 40 mm

**474002002**

MICRA  
Portapapel sin tapa

(C)



**Acabados**

Cromo  
165 x 14 x 70 mm

**474001002 / 474010002**

MICRA  
Portapapel sin tapa derecho / izquierdo

(B)



**Acabados**

Cromo  
160 x 45 x 70 mm

**38600121**

METRIC  
Jabonera pared

(C)



**Acabados**

Inox mate  
160 x 20 x 100 mm

**386051002 / 38600102**

METRIC  
Jabonera encimera / Jabonera pared

(C)



**Acabados**

Cromo-vidrio  
160 x 20 x 100 mm



**386020002 / 386020021**

METRIC  
Jabonera ducha

**D**



**Acabados**

Cromo e Inox mate  
340 x 60 x 120 mm / 220 x 60 x 120 mm

**386030002**

METRIC  
Jabonera ducha

**C**



**Acabados**

Cromo  
220 x 24 x 220 mm

**381481002 / 381481021**

METRIC  
Toallero

**B**



**Acabados**

Cromo e Inox mate  
220/300/400/500/600 x 20 x 70 mm

**381443002 / 381443021**

METRIC  
Toallero doble

**C**



**Acabados**

Cromo e Inox mate  
500 x 20 x 100 mm / 600 x 20 x 100 mm

**387050002 / 387050021**

**387001002 / 387001021**

METRIC  
Portacepillos encimera / Portacepillos pared

**C**



**Acabados**

Cromo e Inox mate  
70 x 110 x 70 mm / 80 x 110 x 70 mm

**387831002 / 387831021**

**387801002 / 387801021**

METRIC  
Dosificador encimera  
Dosificador pared

**D**



**Acabados**

Cromo e Inox mate  
50 x 200 x 50 mm / 50 x 200 x 60 mm

**381401002 / 381401021**

METRIC  
Toallero lateral

**C**



**Acabados**

Cromo e Inox mate  
90 x 45 x 400 mm

**382005002 / 382005021**

METRIC  
Toallero aro

**D**



**Acabados**

Cromo e Inox mate  
180 x 210 x 70 mm

**387502002**

METRIC  
Frasco

**E**



**Acabados**

Cromo  
80 x 150 x 80 mm / 120 x 110 x 120 mm

**385040002 / 385040021**

METRIC  
Estante

**C**



**Acabados**

Cromo  
400 x 20 x 130 mm / 600 x 20 x 130 mm

**385110002 / 385110021**

METRIC  
Toallero estante

**E**



**Acabados**

Cromo e Inox mate  
600 x 110 x 300 mm

**384042002 / 384042021**

METRIC  
Portapapel vertical

**B**



**Acabados**

Cromo e Inox mate  
40 x 170 x 90 mm

## 384001002 / 384001021

METRIC  
Portapapel sin tapa

(C)



### Acabados

Cromo e Inox mate  
40 x 170 x 80 mm

## 384002002 / 384002021 / 384010002

METRIC  
Portapapel sin tapa derecho / izquierdo

(B)



### Acabados

Cromo e Inox mate  
150 x 40 x 80 mm

## 384020002

METRIC  
Portapapel doble sin tapa

(C)



### Acabados

Cromo  
320 x 20 x 80 mm

## 389050002 / 389050021

METRIC  
Escobillero suelo

(E)



### Acabados

Cromo e Inox mate  
80 x 590 x 90 mm

## 389001002 / 389001021

METRIC  
Escobillero pared

(E)



### Acabados

Cromo e Inox mate  
80 x 590 x 90 mm

## 381901002

METRIC  
Escobillero / Portapapel suelo

(E)



### Acabados

Cromo  
270 x 640 x 180 mm

## 483BA

PLATFORM  
Jabonera

(B)

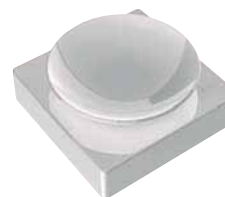

### Acabados

Nylon blanco, negro, beige, gris, amarillo pastel, amarillo, azul pastel, azul, gris, verde y rojo  
120 x 45 x 120 mm

## 481BA

PLATFORM  
Portapapel sin tapa

(A)



### Acabados

Nylon blanco, negro, beige, amarillo pastel, amarillo, azul pastel, azul, gris, verde y rojo  
157 x 45 x 126 mm

## 483BBA

PLATFORM  
Portacepillos

(B)



### Acabados

Nylon blanco, negro, beige, amarillo pastel, amarillo, azul pastel, azul, gris, verde y rojo  
120 x 130 x 120 mm

## 481RBA

PLATFORM  
Portapapel de recambio

(B)



### Acabados

Nylon blanco, negro, beige, amarillo pastel, amarillo, azul pastel, azul, gris, verde y rojo  
120 x 234 x 120 mm

## 486BA

PLATFORM  
Escobillero suelo

(C)



### Acabados

Nylon blanco, negro, beige, amarillo pastel, amarillo, azul pastel, azul, gris, verde y rojo  
120 x 438 x 120 mm

## 560001006

D LINE  
Colgador

(A)



### Acabados

d line colors\*  
25 x 25 x 21 mm

**561502006**

D LINE  
Colgador

**B**



**Acabados**

Inox AISI 316L mate y dline colors\*  
14 x 93 x 105 mm

**560502002**

D LINE  
Gancho toallero

**A**



**Acabados**

Inox AISI 316L mate y dline colors\*  
30 x 30 x 34 mm

**704200105**

D LINE  
Vaso

**A**



**Acabados**

Cristal  
76 x 116 x 76 mm

**704202009**

D LINE  
Soporte portavasos

**D**



**Acabados**

Inox AISI 316L mate y dline colors\*  
30 x 14 x 86 mm

**562002104**

D LINE  
Riel para albornoces con 5 ganchos

**E**



**Acabados**

Inox AISI 316L mate y dline colors\*  
1000 x 80 x 52 mm

**703602127**

D LINE  
Jabonera

**D**



**Acabados**

Inox AISI 316L mate y dline colors\*  
143 x 32 x 105 mm

**704302003**

D LINE  
Portacepillos pared

**B**



**Acabados**

Inox AISI 316L mate y dline colors\*  
14 x 14 x 58 mm

**704502011**

D LINE | TOUCHLESS  
Dosificador pared con indicador

**E**



**Acabados**

Inox AISI 316L mate y dline colors\*  
85 x 205 x 125 mm

**702902305**

D LINE  
Jabonera doble

**E**



**Acabados**

Inox AISI 316L mate y dline colors\*  
318 x 78 x 105 mm

**704402008**

D LINE  
Soporte magnético para jabón

**B**



**Acabados**

Inox AISI 316L mate y dline colors\*  
14 x 57 x 38 mm

**704602000**

D LINE  
Dosificador pared con indicador

**E**



**Acabados**

Inox AISI 316L mate y dline colors\*  
255 x 107 x 145 mm

**704602000**

D LINE  
Dosificador pared con indicador

**E**



**Acabados**

Inox AISI 316L mate y dline colors\* | Cobre  
255 x 107 x 145 mm

## 700500056 + 700002129

D LINE  
Repisa para espejo + soportes

**C**



### Acabados

Inox AISI 316L mate y dline colors\*  
630 x 155 x 45 mm

## 702402500

D LINE  
Estante rejilla para toallas de mano

**E**



### Acabados

Inox AISI 316L mate y dline colors\*  
308 x 45 x 14 mm

## 705602242

D LINE  
Portapapel sin tapa

**D**



### Acabados

Inox AISI 316L mate y dline colors\*  
145 x 18 x 94 mm

## 705602242

D LINE  
Portapapel sin tapa

**D**

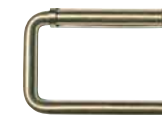

### Acabados

Inox AISI 316L mate y dline colors\* | Latón mate  
145 x 18 x 94 mm

## 705002305

D LINE  
Toallero

**C**



### Acabados

Inox AISI 316L mate y dline colors\*  
300/450/650 x 14/19 x 75/90 mm

## 705402460

D LINE  
Toallero de pared móvil

**C**



### Acabados

Inox AISI 316L mate y dline colors\*  
465 x 145 x 18 mm

## 706202016

D LINE  
Portapapel auxiliar

**B**



### Acabados

Inox AISI 316L mate y dline colors\*  
50 x 160 x 72 mm

## 708102000 / 708102200

D LINE | TOUCHLESS  
Dispensador de toallas de papel

**E**



### Acabados

Inox AISI 316L mate y dline colors\*  
348 x 400 x 225 mm / 386 x 400 x 225 mm

## 461402306 / 461702309

D LINE  
Asidero fijo

**D**



### Acabados

Inox AISI 316L mate y dline colors\*  
300/650 x 85 x Ø32 mm

## 705402465

D LINE  
Portapapel doble sin tapa

**D**



### Acabados

Inox AISI 316L mate y dline colors\*  
275/320 x 18 x 94 mm

## 708002004

D LINE  
Dispensador de toallas de papel

**E**



### Acabados

Inox AISI 316L mate y dline colors\*  
285 x 300 x 113 mm

## 708202010

D LINE  
Secador de manos

**E**



### Acabados

Inox AISI 316L mate y dline colors\*  
386 x 400 x 225 mm

**706102100**

D LINE  
Escobillero pared

**E**



**Acabados**

Inox AISI 316L mate y dline colors\*  
85 x 390 x 170 mm

**706102100**

D LINE  
Escobillero pared

**E**



**Acabados**

Inox AISI 316L mate y dline colors\* | Antracita  
85 x 390 x 170 mm

**706002007**

D LINE  
Kit: (2 U.) ganchos toalleros, (1 U.) portapapel,  
(1 U.) portapapel auxiliar, (1 U.) escobillero pared

**E**



**Acabados**

Inox AISI 316L mate y dline colors\*

**1200198**

LUNAR  
Jabonera

**A**



**Acabados**

Blanco y Blanco-gris claro/naranja/rojo/  
verde/azul claro/piedra/negro  
125 x 30 x 90 mm

**1201698 / 1200298**

LUNAR  
Vaso

**A**



**Acabados**

Blanco y Blanco-gris claro/naranja/rojo/  
verde/azul claro/piedra/negro  
75 x 100 x 75 mm / 80 x 120 x 80 mm

**1200398**

LUNAR  
Portacepillos encimera

**A**



**Acabados**

Blanco y Blanco-gris claro/naranja/rojo/  
verde/azul claro/piedra/negro  
80 x 120 x 80 mm

**1200798**

LUNAR  
Dosificador encimera

**A**



**Acabados**

Blanco y Blanco-gris claro/naranja/rojo/  
verde/azul claro/piedra/negro  
80 x 140 x 80 mm

**1200498**

LUNAR  
Frasco

**A**



**Acabados**

Blanco y Blanco-gris claro/naranja/rojo/  
verde/azul claro/piedra/negro  
100 x 120 x 100 mm

**1200998**

LUNAR  
Portapapel sin tapa

**A**



**Acabados**

Blanco y Blanco-gris claro/naranja/rojo/  
verde/azul claro/piedra/negro  
125 x 35 x 100 mm

**1200598 / 1201598**

LUNAR  
Escobillero suelo / Escobillero pared

**B**



**Acabados**

Blanco y Blanco-gris claro/naranja/rojo/  
verde/azul claro/piedra/negro  
125 x 415 x 125 mm / 100 x 395 x 100 mm

**1200698**

LUNAR  
Papelera

**B**



**Acabados**

Blanco y Blanco-gris claro/naranja/rojo/  
verde/azul claro/piedra/negro  
190 x 280 x 190 mm / 6 L

**1200698**

LUNAR  
Papelera

**B**



**Acabados**

Blanco y Blanco-gris claro/naranja/rojo/  
verde/azul claro/piedra/negro  
190 x 280 x 190 mm / 6 L

**2773621**

GEYSER  
Colgador

**A**



**Acabados**

Negro mate  
44 x 44 x 40 mm

**2773632**

GEYSER  
Jabonera

**A**



**Acabados**

Negro mate  
130 x 21 x 130 mm

**2773600**

GEYSER  
Escobillero suelo

**B**



**Acabados**

Negro mate  
100 x 400 x 100 mm

**2773602**

GEYSER  
Papelera

**B**



**Acabados**

Negro mate  
200 x 260 x 200 mm

**2773651**

GEYSER  
Portacejillos encimera

**A**



**Acabados**

Negro mate  
73 x 140 x 73 mm

**2773604**

GEYSER  
Dosificador encimera

**B**



**Acabados**

Negro mate  
60 x 200 x 80 mm

**2773684**

GEYSER  
Espejo aumento encimera (x5)

**B**



**Acabados**

Negro mate  
180 x 240 x 90 mm

**2773658**

GEYSER  
Portapapel sin tapa

**B**



**Acabados**

Negro mate  
44 x 44 x 144 mm

DESCARGAR  
CATÁLOGO



05

TOPES DE PUERTA  
PERCHAS Y COLGADORES

### MA01136

Suelo

C



#### Acabados

Cromo y Cromo mate-goma negra  
30 x 30 mm

### A0490

Suelo

A



#### Acabados

Inox mate-goma negra  
20 x 20 mm

### IN1318530

Suelo

C



#### Acabados

Inox mate-goma negra  
Ø30 x 30 mm

### MA01135

Suelo

C



#### Acabados

Cromo y Cromo mate-goma negra  
35 x 17 mm

### 508002015 / 30

KNUD HOLSCHER

Suelo - Puertas pesadas

E



#### Acabados

Inox AISI 316L mate-goma negra  
80 x 15 x 80 mm / 80 x 30 x 80 mm

### 508002000

KNUD HOLSCHER

Suelo - Puertas pesadas

E



#### Acabados

Inox AISI 316L mate-goma negra  
Ø70 x 30 mm

## 420IM

Suelo

**C**



### Acabados

Inox mate-goma negra  
20 x 35 mm

## I166

Suelo

**B**



### Acabados

Inox mate-goma negra e Inox mate-goma transparente  
20 x 30 mm

## I181TIM

Suelo

**B**



### Acabados

Inox mate-goma transparente  
Ø20 x 25 mm

## 507002006

KNUD HOLSCHER

Suelo

**E**



### Acabados

Inox AISI 316L mate-goma negra  
Ø40 x 38 mm

## I108

Suelo

**A**



### Acabados

Inox mate, Inox brillo, Latón pulido, Latón mate,  
Color cuero, Níquel mate, Negro-goma negra  
Ø20 x 28 mm

## 3816F1

Suelo

**E**



### Acabados

Aluminio-goma negra  
Ø60 x 25 mm

## PA2CM

Suelo

**C**



### Acabados

Cromo, Cromo mate, Cromo negro, Blanco  
y Latón pulido-goma negra  
Ø50 x 27 mm

## PA3CM

Suelo

**C**



### Acabados

Cromo, Cromo mate, Níquel mate, Latón mate y  
Latón pulido-goma negra  
Ø50 x 21 mm

## 2040IM

Suelo

**D**



### Acabados

Inox AISI 316L mate-goma negra  
Ø51 x 60 mm

## 100NGIM

Suelo

**B**



### Acabados

Inox mate-goma negra  
Ø45 mm

## 3881F1

Suelo

**D**



### Acabados

Aluminio F1-goma negra  
Ø45 x 30 mm

## 2027CR

Adhesivo suelo

**A**



### Acabados

Cromo, Cromo mate, Negro y Blanco-goma negra  
Ø47 x 14 mm



## L190

Suelo

**D**



### Acabados

Cromo, Cromo mate, Bruñito y Oro brillo-goma negra  
Ø40 x 25 mm

## TLNG / TLBL

Suelo

**B**



### Acabados

Bronce, Negro y Blanco-goma negra  
Ø45

## 1MFRA

Suelo

**C**



### Acabados

Fragua y Óxido-goma negra  
20 x 30 mm

## 2MFRA

Suelo

**C**



### Acabados

Fragua y Óxido-goma negra  
Ø20 x 30 mm

## 2617

Suelo

**C**



### Acabados

Titán-goma negra  
20 x 32 mm

## TLBR

Suelo

**B**



### Acabados

Bronce, Negro y Blanco-goma negra  
Ø45

## I108ELM

Suelo

**B**



### Acabados

Inox mate, Inox brillo, Latón pulido, Latón mate,  
Color cuero, Níquel mate y Negro-goma negra  
Ø20 x 28 mm

## L190

Suelo

**D**



### Acabados

Cromo, Cromo mate, Bruñito y Oro brillo-goma negra  
Ø40 x 25 mm

## I108NG

Suelo

**B**



### Acabados

Inox mate, Inox brillo, Latón pulido, Latón mate,  
Color cuero, Níquel mate y Negro-goma negra  
Ø20 x 28 mm

## PA3LM / PA3LP

Suelo

**C**



### Acabados

Cromo, Cromo mate, Níquel mate, Latón mate y  
Latón pulido-goma negra  
Ø50 x 21 mm

## PA2LP

Suelo

**C**



### Acabados

Cromo, Cromo mate, Cromo negro, Blanco  
y Latón pulido-goma negra  
Ø50 x 27 mm

## C52200LP

ENRICO CASSINA

Suelo

**D**



### Acabados

Latón pulido-goma negra  
Ø41 x 37 mm

## L193LA

Suelo - Con retenedor magnético

**E**



### Acabados

Cromo, Cromo mate, Latón pulido y Latón antiguo  
54 x 31 x 34 mm

## L193CM

Suelo - Con retenedor magnético

**E**



### Acabados

Cromo, Cromo mate, Latón pulido y Latón antiguo  
54 x 31 x 34 mm

## I162TIM

Adhesivo suelo

**C**



### Acabados

Inox mate-goma transparente  
24 x 19 mm

## I203

Adhesivo suelo

**C**



### Acabados

Inox mate-goma blanca  
Ø35 x 12 mm

## 813

Suelo con retenedor

**C**



### Acabados

Níquel mate y Cromo brillo-goma negra  
Ø25 x 105 x 28 mm

## 100GR

Suelo móvil

**C**



### Acabados

Inox mate-goma negra  
Ø100 x 40 mm

## 20BIM

Adhesivo suelo

**B**



### Acabados

Inox mate, Inox brillo y Latón mate-goma negra  
Ø55 x 17 mm

## 20BLT

Adhesivo suelo

**B**



### Acabados

Inox mate, Inox brillo y Latón mate-goma negra  
Ø55 x 17 mm

## FANTOM

Suelo con retenedor

**D**



### Acabados

Transparente

## 2098

Adhesivo alta resistencia

**B**



### Acabados

Transparente-goma transparente  
Ø46 x 18 mm

## 5009FRA

Adhesivo suelo

**A**



### Acabados

Fragua y Óxido-goma transparente  
Ø53 x 18 mm

## 50110X

Adhesivo suelo

**A**



### Acabados

Fragua y Óxido-goma transparente  
Ø53 x 18 mm

## 2027NG / 2027BL

Adhesivo suelo

**A**



### Acabados

Cromo, Cromo mate, Negro y Blanco-goma negra  
Ø47 x 14 mm

## I-140

Adhesivo suelo

**C**



### Acabados

Negro-goma negra  
Ø36 x 19 mm

## TPHA / TMHA

Suelo móvil

**D**



### Acabados

Haya, Nogal, Lacado blanco y Lacado negro  
Ø110 x 19 mm / Ø170 x 30 mm

## TPNO / TMNO

Suelo móvil

**D**



### Acabados

Haya, Nogal, Lacado blanco y Lacado negro  
Ø110 x 19 mm / Ø170 x 30 mm

## I-163

Adhesivo suelo

**B**



### Acabados

Negro-goma negra e Inox mate-goma transparente  
Ø24 x 20 mm

## 2420

Adhesivo suelo con amortiguador

**A**



### Acabados

Negro  
Ø40 x 24 mm

**D**

## TPBL / TPNG

Suelo móvil

**D**



### Acabados

Haya, Nogal, Lacado blanco y Lacado negro  
Ø110 x 19 mm

## 6410

TOM HIGGS  
Suelo móvil / ventana

**C**



### Acabados

Goma gris/negra/naranja  
150 x 40 mm

## I20435IM

Adhesivo suelo

**C**



### Acabados

Inox mate-goma negra  
Ø35 x 19 mm

## I193

Adhesivo suelo

**B**



### Acabados

Inox mate-goma negra  
Ø24 mm / Ø28 mm

## 6410

TOM HIGGS  
Suelo móvil / ventana

**C**



### Acabados

Goma gris/negra/naranja  
150 x 40 mm

## 6410

TOM HIGGS  
Suelo móvil / ventana

**C**



### Acabados

Goma gris/negra/naranja  
150 x 40 mm

**562SS**

Tope percha

**C**



**Acabados**

Inox mate-goma negra  
Ø50 x 72 mm

**7911M**

Pared

**D**



**Acabados**

Inox mate-goma negra  
Ø20 x 75 mm

**562NG**

Pared

**B**



**Acabados**

Nylon blanco/negro/beige/amarillo pastel/amarillo/  
azul pastel/azul/gris/verde/rojo  
Ø53 x 75 mm

**G319**

Pared

**D**



**Acabados**

Negro, Cromo mate, Antracita y Níquel mate  
30 x 30 x 30 mm

**505502001**

KNUD HOLSCHER

Pared

**D**



**Acabados**

Inox mate-goma negra  
Ø20 x 31 mm

**506002002**

KNUD HOLSCHER

Pared

**E**



**Acabados**

Inox mate-goma negra  
Ø14 x 70 mm

**I205**

Adhesivo pared-manilla

**B**



**Acabados**

Inox mate-goma blanca e Inox mate-goma negra  
Ø35 x 19 mm

**I198**

Adhesivo pared-manilla

**B**



**Acabados**

Inox mate-goma blanca e Inox mate-goma negra  
Ø28 x 20 mm

**505002009**

KNUD HOLSCHER

Pared

**D**



**Acabados**

Inox mate-goma negra  
Ø14 x 21 mm

**7901M**

Pared

**C**



**Acabados**

Inox mate-goma negra  
Ø20 x 65 mm

**I205**

Adhesivo pared-manilla

**B**



**Acabados**

Inox mate-goma blanca e Inox mate-goma negra  
Ø35 x 19 mm

**I198**

Adhesivo pared-manilla

**B**



**Acabados**

Inox mate-goma blanca e Inox mate-goma negra  
Ø28 x 20 mm

92022 / 135IM

(B)



**Acabados**

Inox negro e Inox mate  
Ø35 x 42 mm

92023 / 435IM

(B)



**Acabados**

Inox negro e Inox mate  
35 x 35 x 42 mm

F183 / 300

(B)



**Acabados**

Inox negro e Inox mate  
18 x 66 x 36 mm / 25 x 85 x 47 mm / 25 x 110 x 61 mm

F184

(B)



**Acabados**

Inox negro e Inox mate  
100 x 25 mm / 140 x 25 mm / 170 x 25 mm

560002000 / 5600R800

KNUD HOLSCHER

(D)



**Acabados**

Inox negro e Inox mate AISI 316L  
Ø25 x 21 mm

2683621

RICARD FERRER

(D)



**Acabados**

Negro mate, Cromo y Blanco mate  
110 x 16 x 30 mm

DESCARGAR  
CATÁLOGO



2086

(A)

(D)



**Acabados**

Negro mate y Cromo mate  
60 x 68 x 53 mm

PERCHINT

LINDEN

(B)



**Acabados**

Blanco, Gris, Negro, Traslúcido blanco y Traslúcido rojo  
65 x 38 mm

561502006

KNUD HOLSCHER

(D)



**Acabados**

Inox mate AISI 316L  
Ø14 x 93 x 105 mm

84603 / 84604

(C)



**Acabados**

Antracita. Aluminio, Gris y Blanco  
Ø18 x 40 mm / Ø28 x 80 mm

2840 / 2860

(A)



**Acabados**

Cromo, Cromo mate y Níquel mate  
44 x 54 mm / 25 x 56 mm

2850

(A)



**Acabados**

Cromo, Cromo mate y Níquel mate  
49 x 55 mm

F132

(B)



**Acabados**

Inox mate  
Ø20 x 50 mm

4087CR

(A)



**Acabados**

Cromo  
25 x 45 mm

PA00282

BERT & BERT

(C)



**Acabados**

Cromo mate  
110 x 120 mm

PA00279

FRANCO GUANZIROLI

(C)



**Acabados**

Cromo mate  
70 x 60 mm

2510121

(D)



**Acabados**

Cromo  
20 x 70 x 35 mm

2530121

(D)



**Acabados**

Cromo  
20 x 45 x 50 mm

4089

**B**



**Acabados**

Níquel mate  
13 x 40 x 40 mm

4090

**B**



**Acabados**

Níquel mate  
50 x 40 x 40 mm

F190

**B**



**Acabados**

Inox negro e Inox mate  
Ø30 x 40 mm

2773621

NAHRANG

**B**



**Acabados**

Negro mate, Blanco mate,  
Cromo, Piedra y Verde salvia  
Ø44 x 40 mm



PA00276

BERT & BERT

**C**



**Acabados**

Cromo mate  
106 x 57 x 58 mm

PA00284

COLOMBO & VANTUSSO

**D**



**Acabados**

Níquel mate  
60 x 60 x 40 mm

562502000

KNUD HOLSCHER

**F**



**Acabados**

Inox negro e Inox mate AISI 316L  
Ø80 x 52 mm

560502002

KNUD HOLSCHER

**D**



**Acabados**

Inox mate AISI 316L  
Ø30 x 34 mm

272

MARCONATO & ZAPPA

**B**



**Acabados**

Níquel mate y Aluminio plata  
34 x 62 x 31 mm

273

MARCONATO & ZAPPA

**B**



**Acabados**

Níquel mate y Aluminio plata  
36 x 64 x 31mm

F151/2/3

**B**



**Acabados**

Inox mate  
Ø30 x 55 mm / 145 x 30 x 60 mm / 271 x 30 x 60 mm

2050121D (2 U.)

**D**



**Acabados**

Cromo  
Ø35 x 50 mm

428001R8003 / 42800102003

428001R7003 (2 U.)

BJARKE INGELS

**D**



**Acabados**

Inox negro, Inox mate AISI 316L y Blanco  
Ø20 x 20 mm

428001R8001 / 42800102001

428001R7001 (2 U.)

BJARKE INGELS

**E**



**Acabados**

Inox negro, Inox mate AISI 316L y Blanco  
Ø20 x 51,5 mm

ONE

**B**



**Acabados**

Blanco, Negro y Haya  
Ø105 mm

HOOK1 / HOOK3

**B**



**Acabados**

Plástico reciclado con hierba  
1500 x 160 mm / 5 kg x gancho

428001R8002 / 42800102002

428001R7002 (2 U.)

BJARKE INGELS

**D**



**Acabados**

Inox negro, Inox mate AISI 316L y Blanco  
Ø20 x 48 mm

428001R8004 / 42800102004

428001R7004 (3 U.)

BJARKE INGELS

**F**



**Acabados**

Inox negro, Inox mate AISI 316L y Blanco  
Ø20 x 51,5 mm (1 U.) / Ø20 x 48 mm (1 U.)  
Ø20 x 20 mm (1 U.)

3101FRA / 99ALFOX

**A**



**Acabados**

Frágua y Óxido  
48 x 84 x 30 mm

3517 / 3518

**A**



**Acabados**

Hierro negro y Óxido  
75 mm

007

**C**



**Acabados**

Cromo-Cuero azul/piedra/granate/gris/marfil/blanco/  
marrón/marrón oscuro/negro  
70 x 35 x 50 mm

008

**B**



**Acabados**

Cromo-Cuero azul/piedra/granate/gris/marfil/blanco/  
marrón/marrón oscuro/negro  
50 x 31 mm

004

**D**



**Acabados**

Cromo-Cuero azul/piedra/granate/gris/marfil/blanco/  
marrón/marrón oscuro/negro  
33 x 47 mm

FORJAESP / FORJAPLA

ERNEST ALTÉS

**B**



**Acabados**

Forja  
55 x 35 mm / 55 x 45mm



## WARDROP

STOFER & WILDGRUBER

**E**



### Acabados

Poliamida blanca y Gancho cromo mate  
3 m + 4 ganchos

## WARDROP

STOFER & WILDGRUBER

**E**

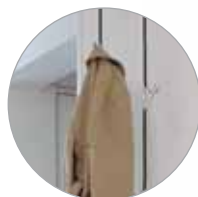

### Acabados

Poliamida negra y Gancho cromo mate  
3 m + 4 ganchos

## PERCH2

HARRIT & SORENSEN

**E**



### Acabados

Madera cerezo/haya/wengué/blanco y Gancho gris  
200 x 79 x 18 mm

## PERCH3

HARRIT & SORENSEN

**E**



### Acabados

"DuPont™ Corian®" blanco/gris/negro y Gancho gris o negro  
200 x 46 x 16 mm



## WARDROP

STOFER & WILDGRUBER

**E**



### Acabados

Poliamida negra y Gancho blanco  
3 m + 4 ganchos

## PERCH4

HARRIT & SORENSEN

**F**



### Acabados

Madera cerezo/haya/wengué/blanco y Gancho gris  
395 x 80 mm

## PERCH4V

HARRIT & SORENSEN

**F**



### Acabados

Madera cerezo/haya y Gancho gris  
80 x 650 mm

## WARDROP

STOFER & WILDGRUBER

**E**



### Acabados

Poliamida roja y Gancho blanco  
3 m + 4 ganchos

## PERCH6

HARRIT & SORENSEN

**F**

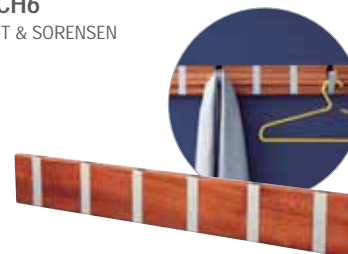

### Acabados

Madera cerezo/haya/wengué/blanco y Gancho gris  
590 x 79 x 18 mm

## PERCH8

HARRIT & SORENSEN

**F**

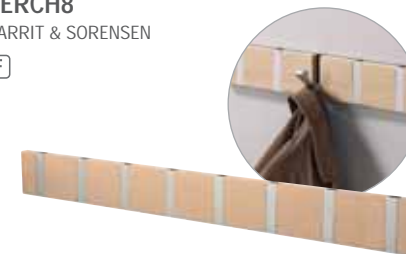

### Acabados

Madera cerezo/haya/wengué/blanco y Gancho gris  
790 x 79 x 18mm

MANUAL  
DE  
CO



Rosselló Nº 21  
08029 - BCN  
936 002 002  
info@arcon.es  
www.arcon.es

